



**G**

**LABORATORY  
LABORATORIO**

# WAX AND MODELLING INSTRUMENTS

## STRUMENTI PER MODELLARE

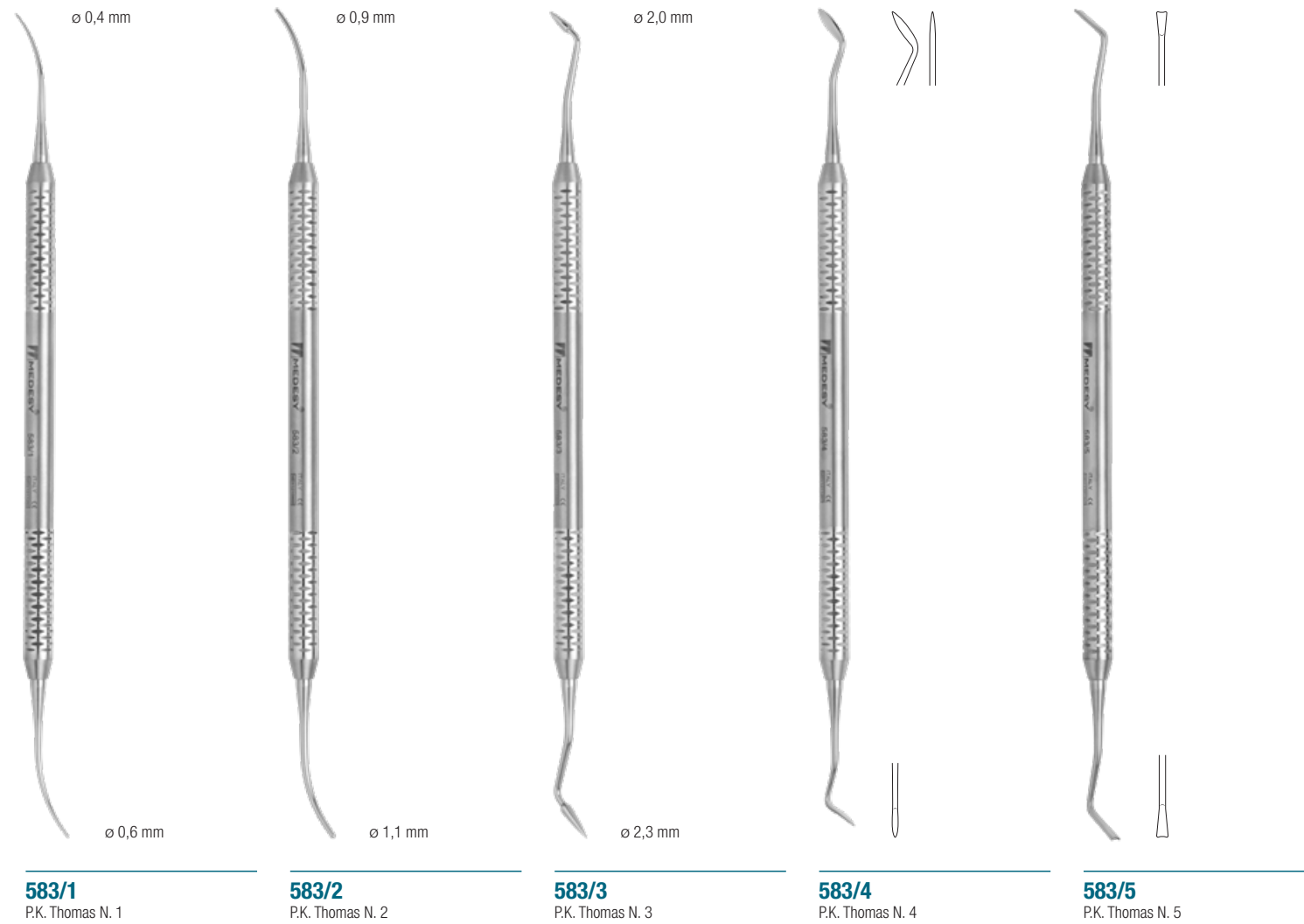

**583/1** P.K. Thomas N. 1  
**583/2** P.K. Thomas N. 2  
**583/3** P.K. Thomas N. 3  
**583/4** P.K. Thomas N. 4  
**583/5** P.K. Thomas N. 5

Stainless steel handle  $\varnothing$  6 mm  
 Manico inox con diametro  $\varnothing$  6 mm

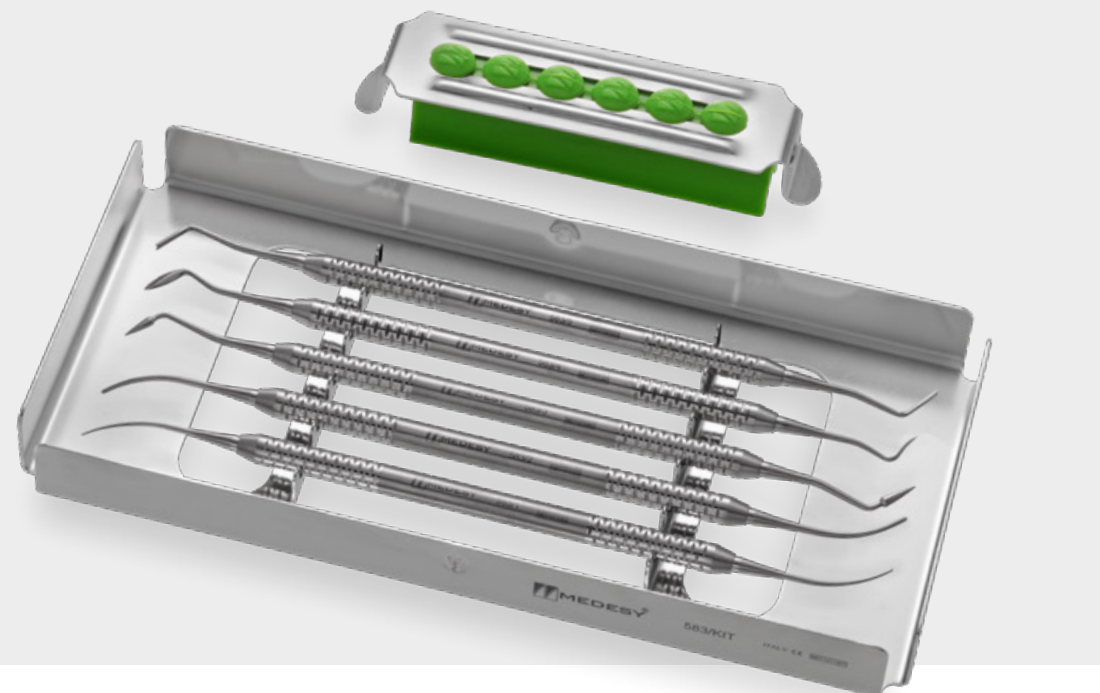

### 583/KIT

Content / Contenuto:

<b>583/1</b>	P.K. Thomas N. 1
<b>583/2</b>	P.K. Thomas N. 2
<b>583/3</b>	P.K. Thomas N. 3
<b>583/4</b>	P.K. Thomas N. 4
<b>583/5</b>	P.K. Thomas N. 5
<b>977</b>	Gammafix tray



Aluminium handle anodized in 5 colors  $\varnothing$  8 mm  
 Manico in alluminio anodizzato in 5 colori diametro  $\varnothing$  8 mm

(1:1 scale / scala 1:1)



**583/1.AL** P.K. Thomas N. 1  
 Aluminium handle yellow  
 Manico in alluminio giallo

**583/2.AL** P.K. Thomas N. 2  
 Aluminium handle green  
 Manico in alluminio verde

**583/3.AL** P.K. Thomas N. 3  
 Aluminium handle blue  
 Manico in alluminio blu

**583/4.AL** P.K. Thomas N. 4  
 Aluminium handle red  
 Manico in alluminio rosso

**583/5.AL** P.K. Thomas N. 5  
 Aluminium handle silver  
 Manico in alluminio argento

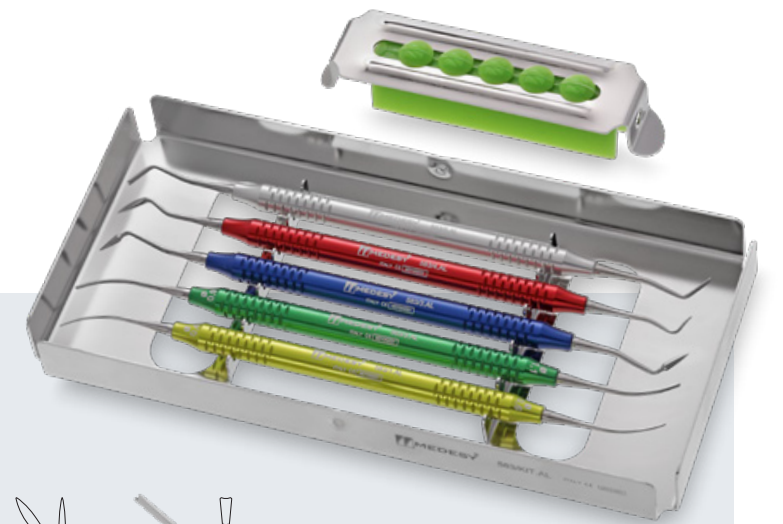

### 583/KIT.AL

Content / Contenuto:

<b>583/1.AL</b>	P.K. Thomas N. 1
<b>583/2.AL</b>	P.K. Thomas N. 2
<b>583/3.AL</b>	P.K. Thomas N. 3
<b>583/4.AL</b>	P.K. Thomas N. 4
<b>583/5.AL</b>	P.K. Thomas N. 5
<b>977</b>	Gammafix tray

## NEWS

# WAX KNIVES COLTELLI PER CERA

(1:1 scale / scala 1:1)



**201** Fahnenstock mm 130  
**202** Fahnenstock mm 180  
**205** Lessmann mm 130  
**206** Lessmann mm 180  
**214** Gritmann mm 170

# WAX AND MODELING INSTRUMENTS STRUMENTI PER MODELLARE

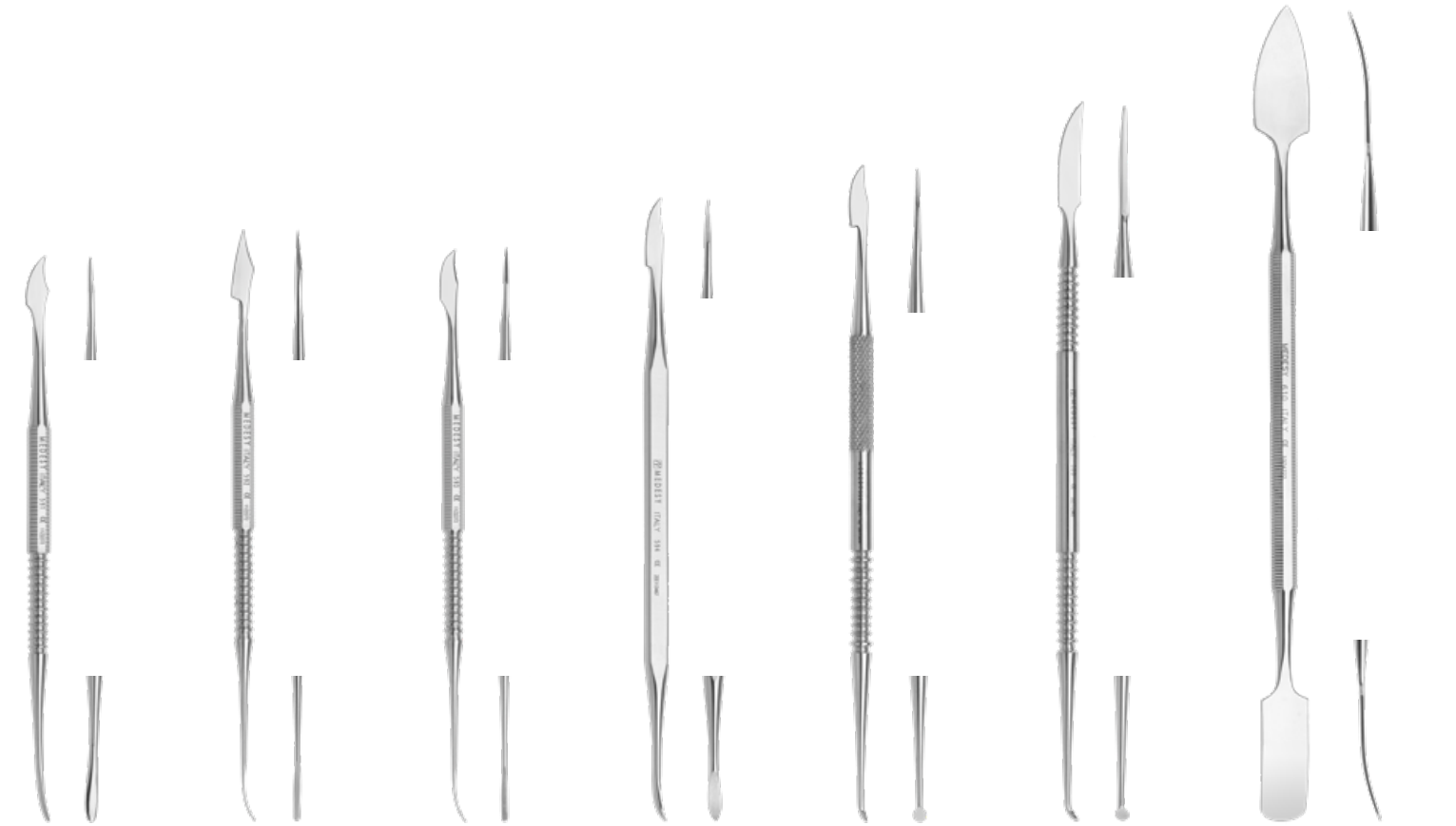

**591** Zahle mm 120  
**592** Zahle mm 130  
**593** Zahle mm 125  
**594** Hylin mm 135  
**596** Hylin mm 145  
**588** Le Cron mm 165  
**610** Gritman mm 180



**599/1** **599/2** **599/3** **599/4** **599/5**

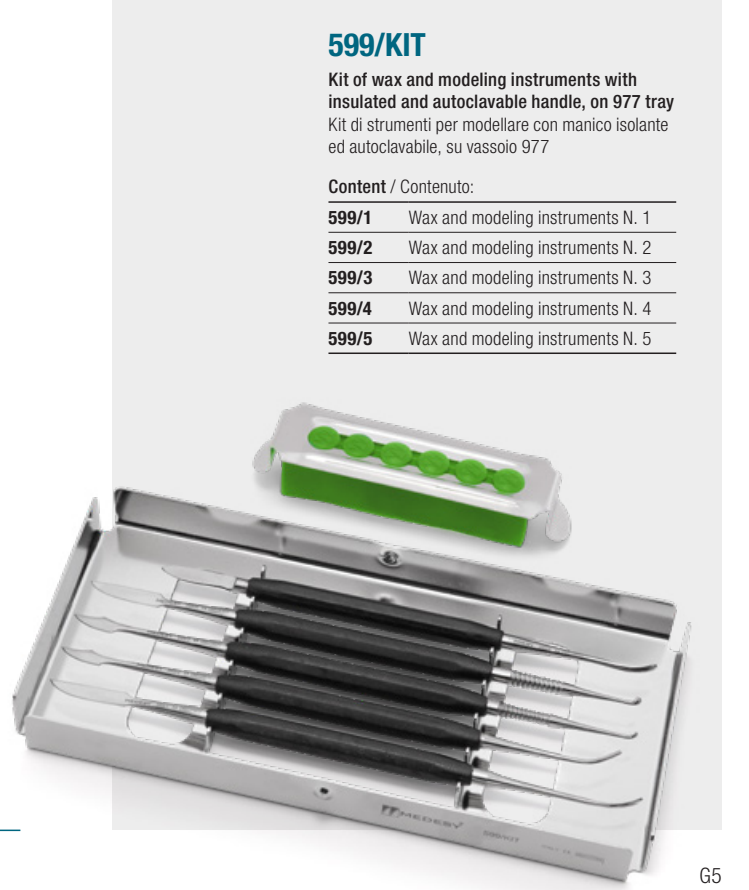

**599/KIT**  
 Kit of wax and modeling instruments with insulated and autoclavable handle, on 977 tray  
 Kit di strumenti per modellare con manico isolante ed autoclavabile, su vassoio 977

**Content / Contenuto:**

- 599/1** Wax and modeling instruments N. 1
- 599/2** Wax and modeling instruments N. 2
- 599/3** Wax and modeling instruments N. 3
- 599/4** Wax and modeling instruments N. 4
- 599/5** Wax and modeling instruments N. 5



# CERAMIC SCULPTING INSTRUMENTS

## STRUMENTI PER CERAMICA

Special set of ceramic sculpting instruments light weight handles and stainless steel tips, different shape: gingival blade, incisal blade and knife blade.

Manici leggeri e punte di forme diverse in acciaio inox, lama gengivale, lama incisale, lama coltello.

(1:1 scale / scala 1:1)



**575/1**  
Greenstein N. 1

**575/2**  
Greenstein N. 2

**575/3**  
Greenstein N. 3



**577/1**   **577/2**   **577/3**

Superflexible tips, thickness 0,1 mm  
Puntali superflessibili, spessore 0,1 mm

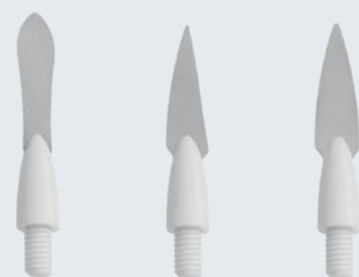

**577/4**   **577/5**   **577/6**

Flexible tips, thickness 0,2 mm  
Puntali flessibili, spessore 0,2 mm



### 575/KIT

Content / Contenuto:

<b>575/1</b>	Greenstein N. 1
<b>575/2</b>	Greenstein N. 2
<b>575/3</b>	Greenstein N. 3
<b>577/1</b>	Superflexible tips N. 1
<b>577/2</b>	Superflexible tips N. 2
<b>577/3</b>	Superflexible tips N. 3
<b>977</b>	Tray

NEWS

(1:1 scale / scala 1:1)

# CERAMIC SCULPTING SPATULA BY DR. COMELLA

## SPATOLA PER CERAMICA BY DR. COMELLA

NEWS

WATCH THE VIDEO  
ON YouTube  
MEDESYS CHANNEL!



Discover how it was born!  
Scopri com'è nata!

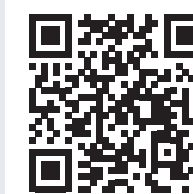

Discover the spatula  
Scopri la spatola



(1:1 scale / scala 1:1)

### 572

Spatula Dr. Comella  
Spatola Dr. Comella

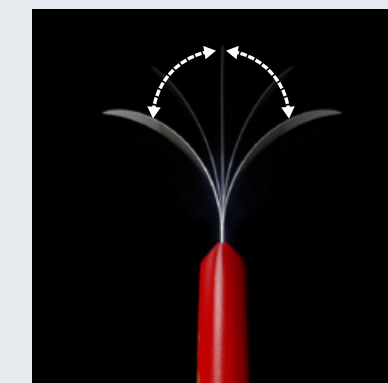

Flexible blade  
Lama flessibile

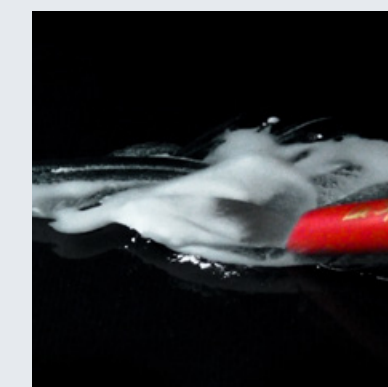

Optimal handling  
Maneggevolezza ottimale

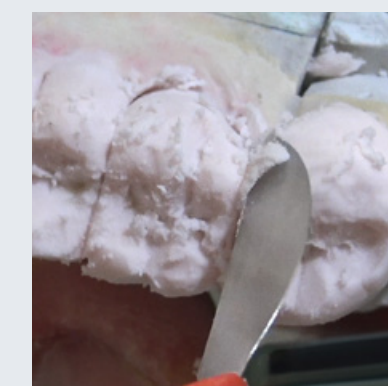

Sharp to refine details  
Affilata per rifinire dettagli



## CEMENT SPATULAS SPATOLE PER CEMENTI

(1:1 scale / scala 1:1)



676/24

4,0



3,5

675/0

5,5



5,5

675/1

6,5



6,5

675/2

7,5



7,5

675/3

9,5



6,5

675/4

NEWS

## PLASTER AND ALGINATE SPATULAS SPATOLE PER GESSO ED ALGINATO



**208**  
Spatula 8 x  
Spatola 8 x  
mm 230



**209**  
mm 215



**210**  
mm 215



**211**  
Curved, rigid  
Curva, rigida  
mm 200



**213/2**  
Rigida  
Rigida  
mm 180



**115**  
Flexible, elastomers  
Flessibile, elastomeri  
mm 190

## PLASTER SHEARS AND SAWS CESOIE PER GESSO E SEGHETTI



**4559**  
Insulated handle  
Manici in plastica  
mm 210

4990



4990/3

Package 12 pcs  
Sacchetti da 12 pezzi  
mm 0,12 x 5

4990/2

Package 12 pcs  
Sacchetti da 12 pezzi  
mm 0,25 x 5

4990/1

Package 12 pcs  
Sacchetti da 12 pezzi  
mm 0,25 x 3

NEWS

## ARTICULATOR ARTICOLATORE

Medesy new articulator non-Arcon average value, solidly manufactured in cast aluminium, about 580gr in weight. Projected and realized to ensure the largest visual field on the lingual surfaces as well as maintaining complete stability of the upper frame also at full open position: coiled springs facilitate the return to starting aligned position. Additional features guarantee an exact simulation of the condylar path with a high fitting accuracy, giving the necessary occlusion function throughout the full range of mandibular movements.

Technical details:

- ▷ Stable 60° operation for technician comfort.
- ▷ Ideal for class III patients.
- ▷ Compatible with any pressure polymerizers.
- ▷ Anti-rotation system for incisal rod.
- ▷ Template with elliptic references for lower arches models.
- ▷ Occlusal table with elliptic references for upper arches models.

Questo è il nuovo articolatore non-Arcon a valor medio di Medesy, prodotto in alluminio pressofuso dal peso di 580gr circa. È stato progettato e realizzato in modo da lasciar ampia visibilità alle superfici linguali, preservando la stabilità in posizione aperta: il ritorno in asse è agevolato grazie a delle molle di richiamo. Le regolazioni di questo articolatore permettono di simulare esattamente il tragitto condiloideo per garantire precisione e occlusione ottimali, qualunque sia il movimento mandibolare del paziente.

Dettagli tecnici:

- ▷ Design per posizione di lavoro ergonomica a 60°.
- ▷ Compatibile per dimensione con i polimerizzatori a pressione in commercio.
- ▷ Sistema anti-rotazione per asta incisale.
- ▷ Calotta con traiettorie ellittiche di riferimento per modelli a partire da arcata inferiore.
- ▷ Piano oclusale con traiettorie ellittiche di riferimento per modelli a partire da arcata superiore.



NEWS

5222

Articulator with mounting plate  
Articolatore con piastra



5222/1

Mounting plate  
Piastra



5222/12

Complete magnet plate  
Piastra magnetica completa

## SET FOR MOBILE DENTAL PROSTHESIS SET PER PROTESI MOBILE

MEDESY  
ITALY

600  
YEARS



2105/Set

Content / Contenuto:

- 588 Wax and modeling instrument, Le Cron
- 593 Wax and modeling instrument, Zahle

592 Wax and modeling instrument, Zahle

202 Wax knife Fahnenstock

206 Wax knife Lessmann

201 Wax knife Fahnenstock

214 Wax knife Gritmann

221 Soldering tweezers, straight

1519 Ligature forceps, Halstead Mosquito

3511 Surgical scissors, Iris straight

3522 Crown and gold scissors, saw edge

3633 Scalpel handle N 3

4981 Caliper Iwanson

2810 Wire bending pliers, universal

Content can be changed upon request / Su richiesta il contenuto può essere cambiato

## SET FOR FIXED DENTAL PROSTHESIS SET PER PROTESI FISSA



2100/Set

Content / Contenuto:

583/1.AL Modeling instrument, aluminium

583/2.AL Modeling instrument, aluminium

583/3.AL Modeling instrument, aluminium

583/4.AL Modeling instrument, aluminium

583/5.AL Modeling instrument, aluminium

3511 Surgical scissors, Iris straight

1519 Forceps Halstead Mosquito

1024 Cotton tweezers, Meriam

3633 Scalpel handle N. 3

596 Modeling instrument, Hylin

594 Modeling instrument, Hylin

575/1 Ceramic sculpting instrument

575/2 Ceramic sculpting instrument

575/3 Ceramic sculpting instrument

Content can be changed upon request / Su richiesta il contenuto può essere cambiato



**IMPRESSION TRAYS, 6000 LINE**  
PORTAIMPRONTE, LINEA 6000

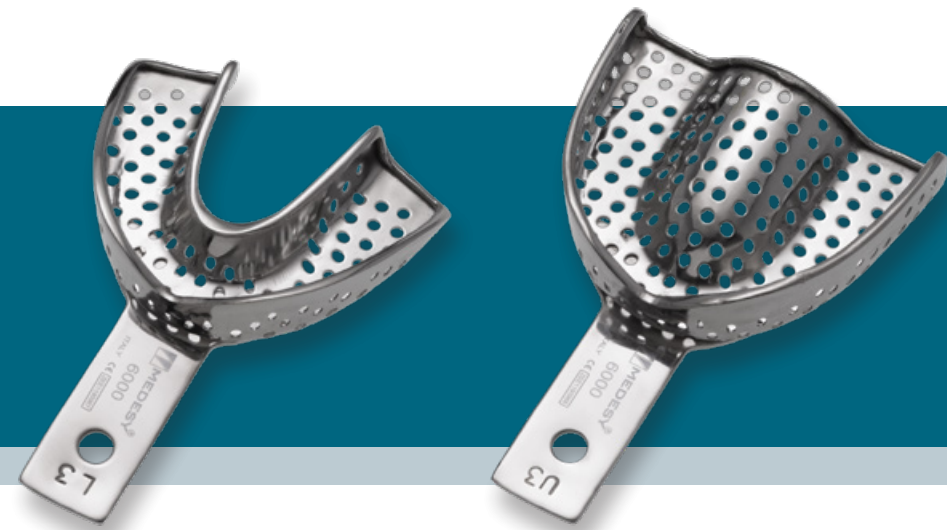

PERFORATED  
FORATE



RETENTION RIM  
BORDO RITENTIVO



**IMPRESSION TRAYS, 6003 LINE**  
PORTAIMPRONTE, LINEA 6003

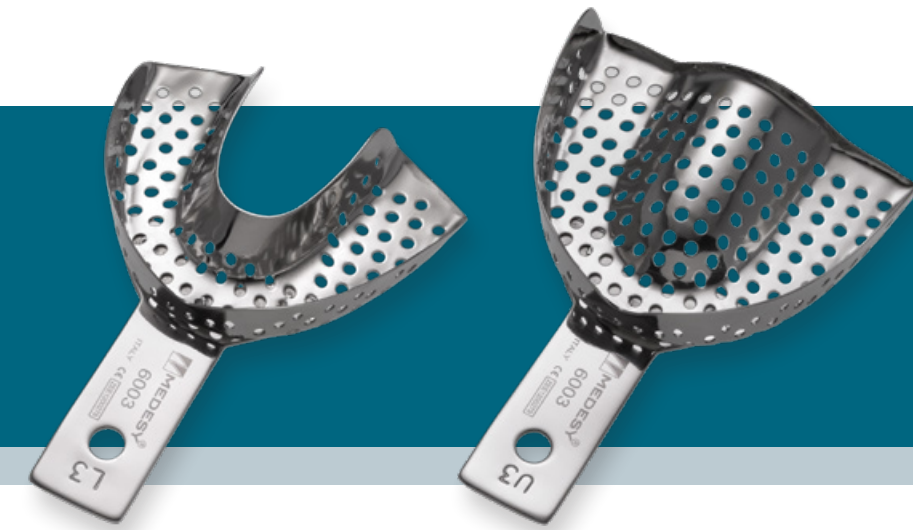

PERFORATED  
FORATE



WITHOUT RETENTION RIM  
SENZA BORDO RITENTIVO

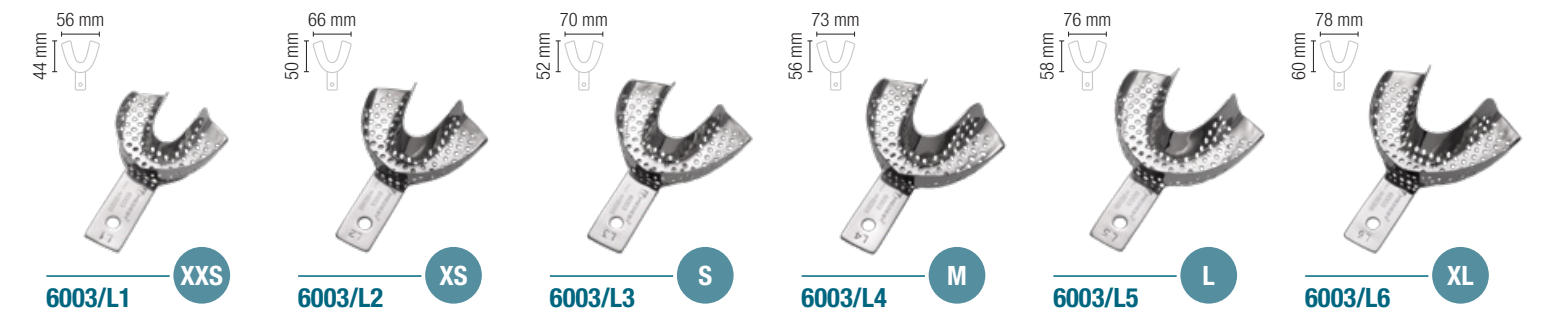
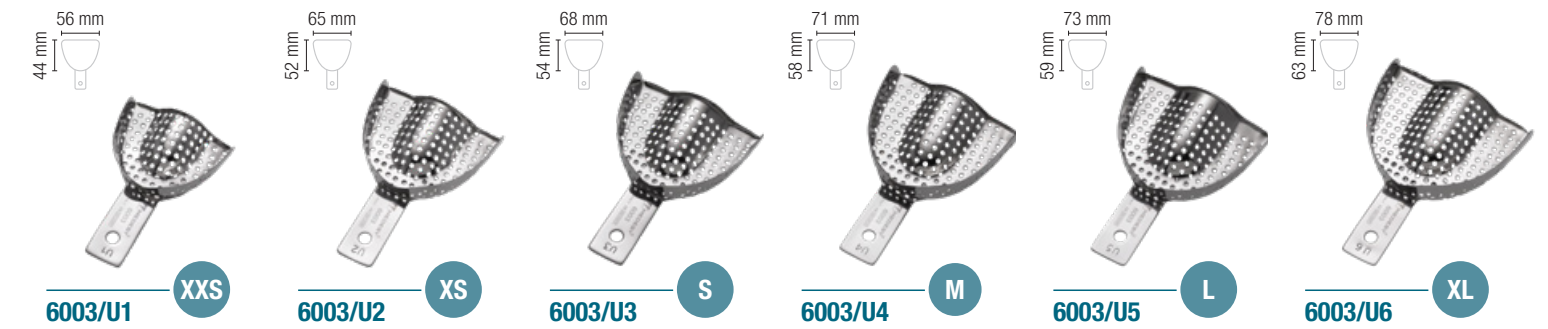
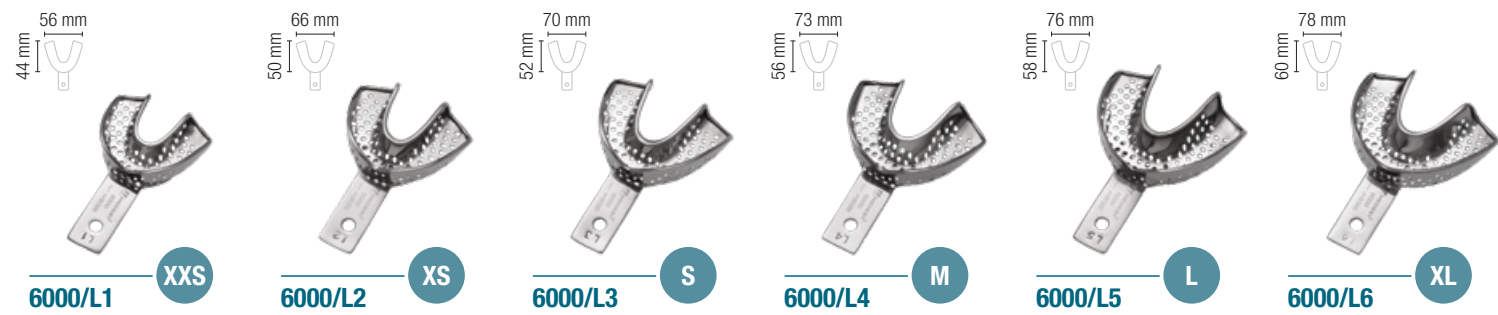
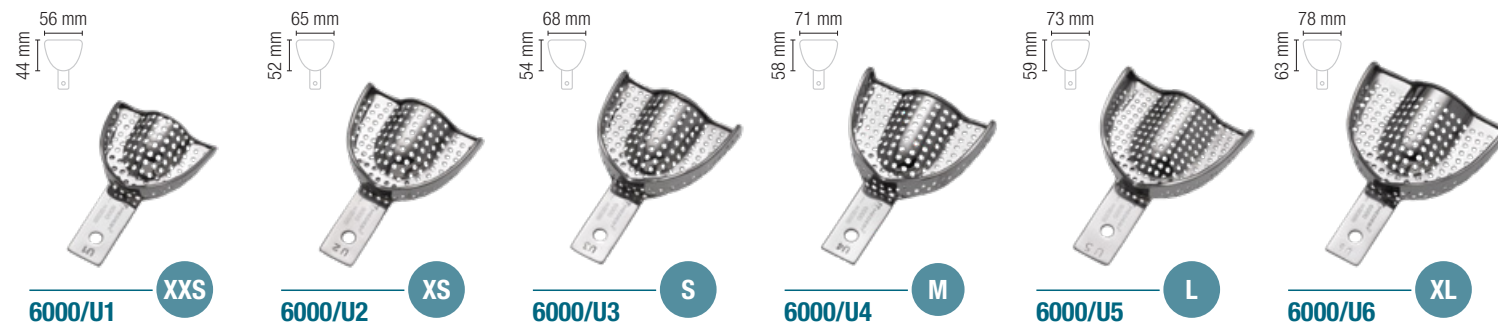

**6000/KIT**  
Contains 12 pcs  
Contiene 12 pz



**6000/4 DR**  
Partial right  
Parziale destro



**6000/4 SL**  
Partial left  
Parziale sinistro



**6003/4 DR**  
Partial right  
Parziale destro



**6003/4 SL**  
Partial left  
Parziale sinistro

**6003/KIT**  
Contains 12 pcs  
Contiene 12 pz





**IMPRESSION TRAYS, 6005 LINE**  
PORTAIMPRONTE, LINEA 6005



**NOT PERFORATED**  
NON FORATE

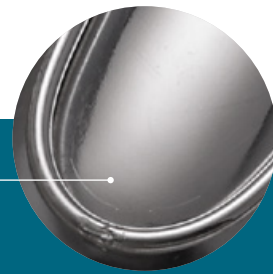

**RETENTION RIM**  
BORDO RITENTIVO

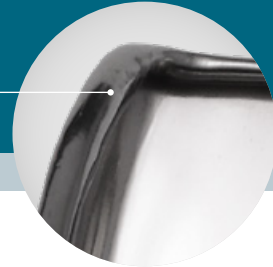

**6005/KIT**  
Contains 12 pcs  
Contiene 12 pz



**6005/4 DR**  
Partial right  
Parziale destro



**6005/4 SL**  
Partial left  
Parziale sinistro

**IMPRESSION TRAYS, 6004 LINE**  
PORTAIMPRONTE, LINEA 6004

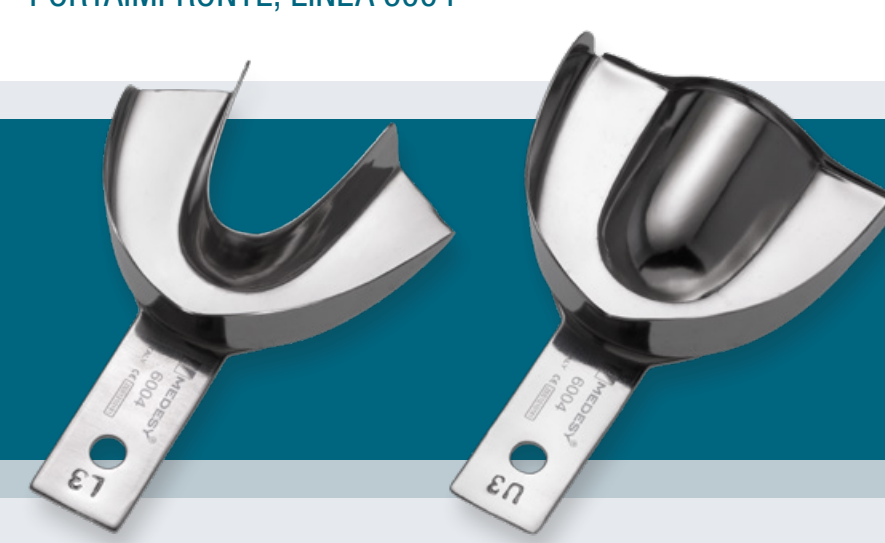

**NOT PERFORATED**  
NON FORATE

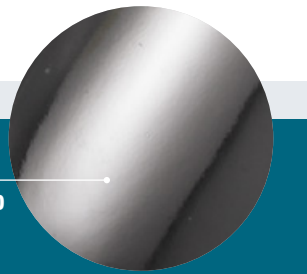

**WITHOUT RETENTION RIM**  
SENZA BORDO RITENTIVO

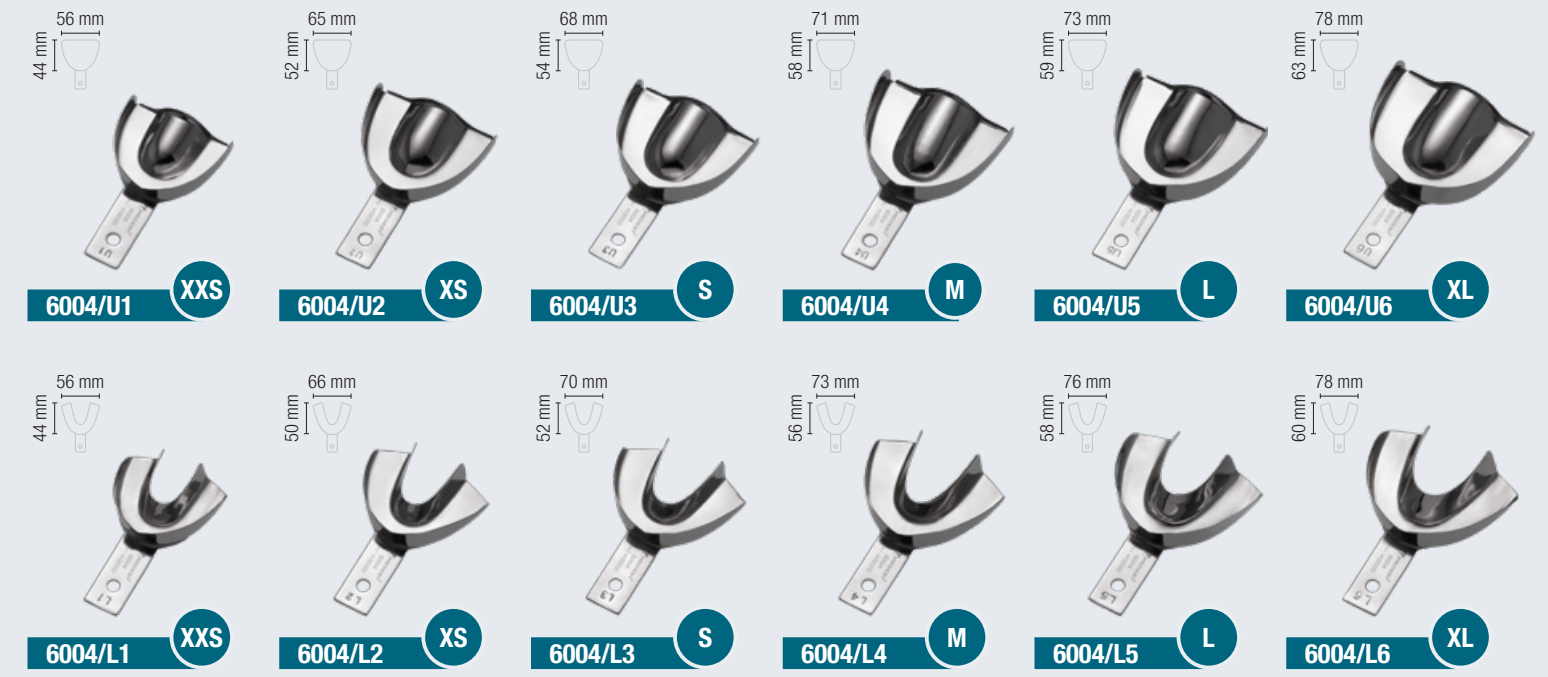

**6004/KIT**  
Contains 12 pcs  
Contiene 12 pz

**NEWS**



**6004/4 DR**  
Partial right  
Parziale destro



**6004/4 SL**  
Partial left  
Parziale sinistro

**IMPRESSION TRAYS, EDENTULOUS**  
PORTAIMPRONTE, EDENTULI

**IMPRESSION TRAYS, EDENTULOUS**  
PORTAIMPRONTE, EDENTULI

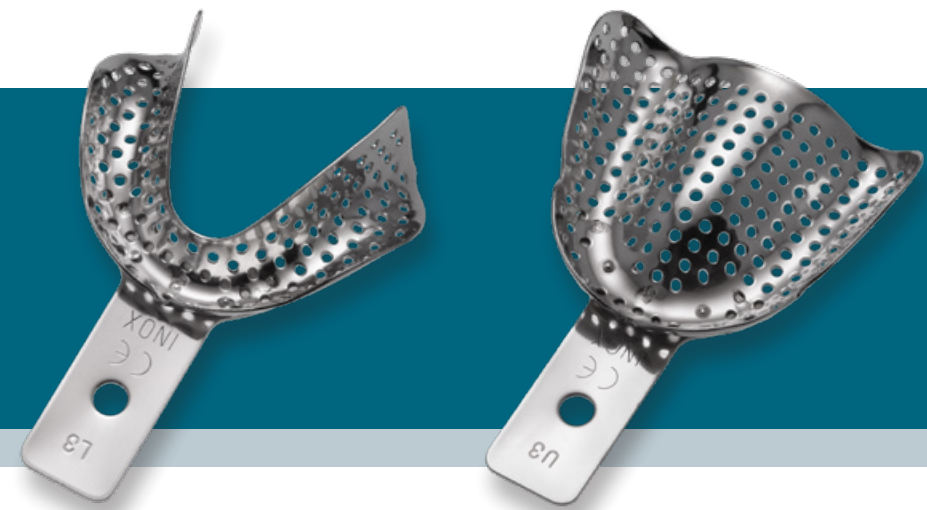

PERFORATED  
FORATE



NOT PERFORATED  
NON FORATE

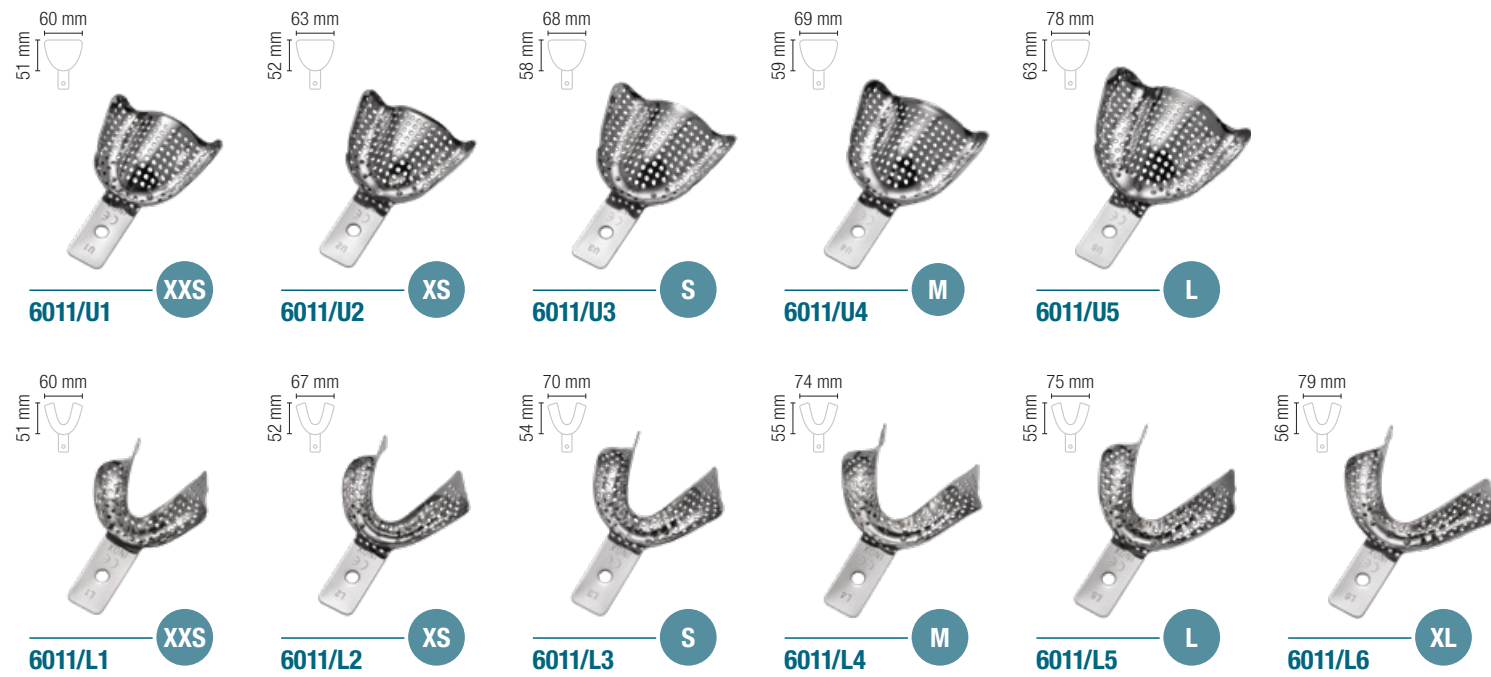

**6011/KIT**  
Contains 11 pcs  
Contiene 11 pz



**6009/KIT**  
Contains 11 pcs  
Contiene 11 pz





**IMPRESSION TRAYS, ALUMINIUM**  
PORTAIMPRONTE, ALLUMINIO

**IMPRESSION TRAYS, DISPOSABLE**  
PORTAIMPRONTE, MONOUSO

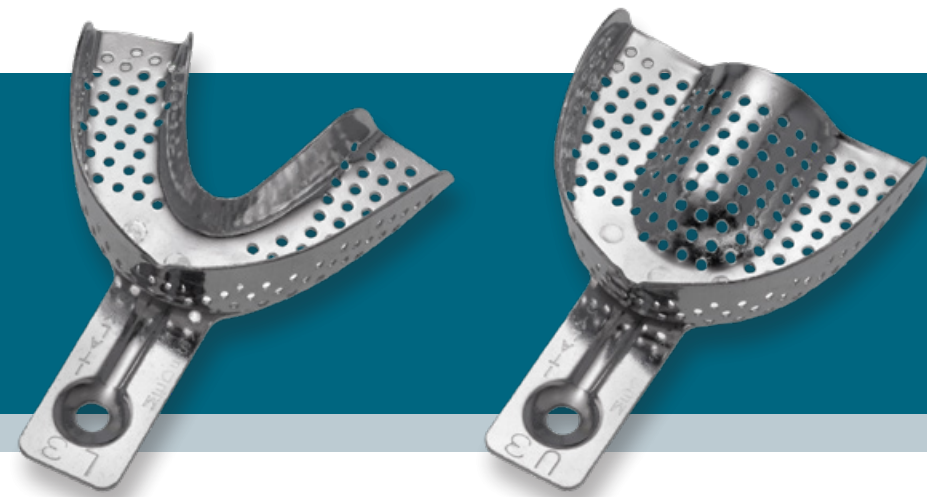

PERFORATED  
FORATE

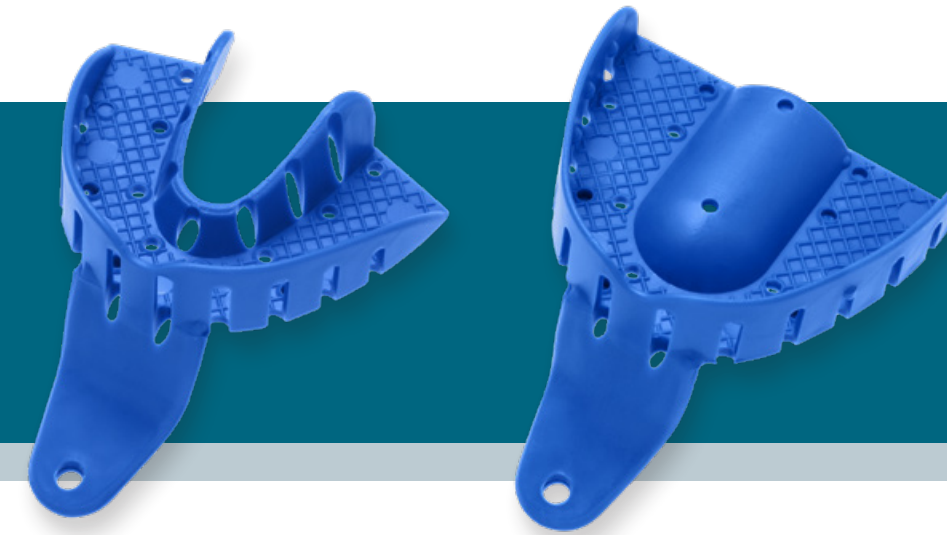
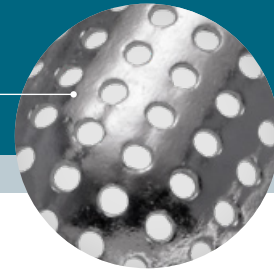

AUTOCLAVABILE AT 121° C  
AUTOCLAVABILI A 121° C

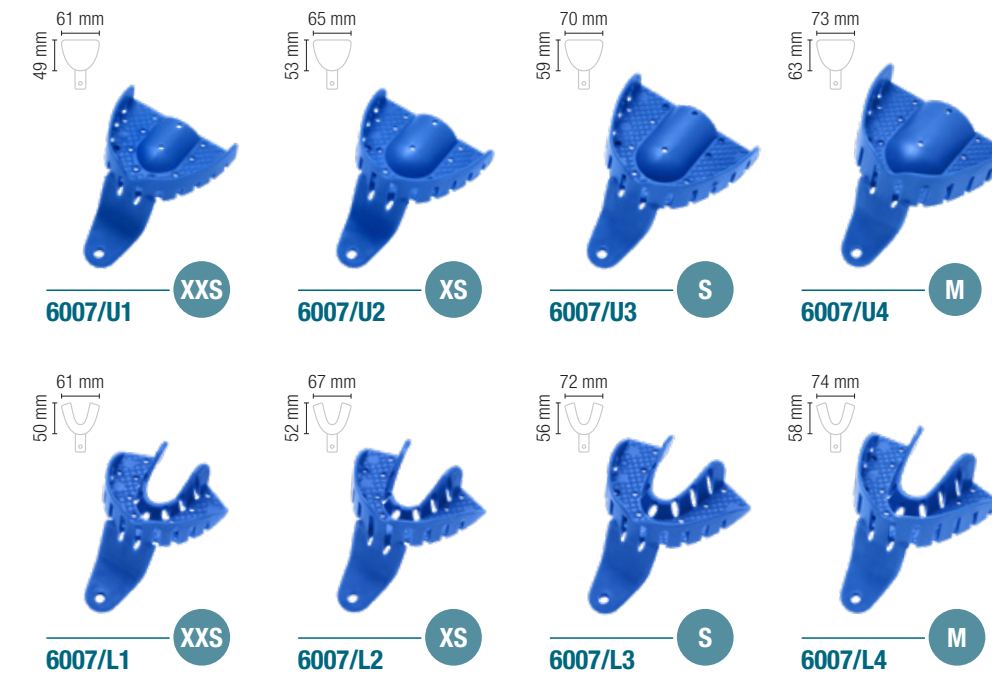
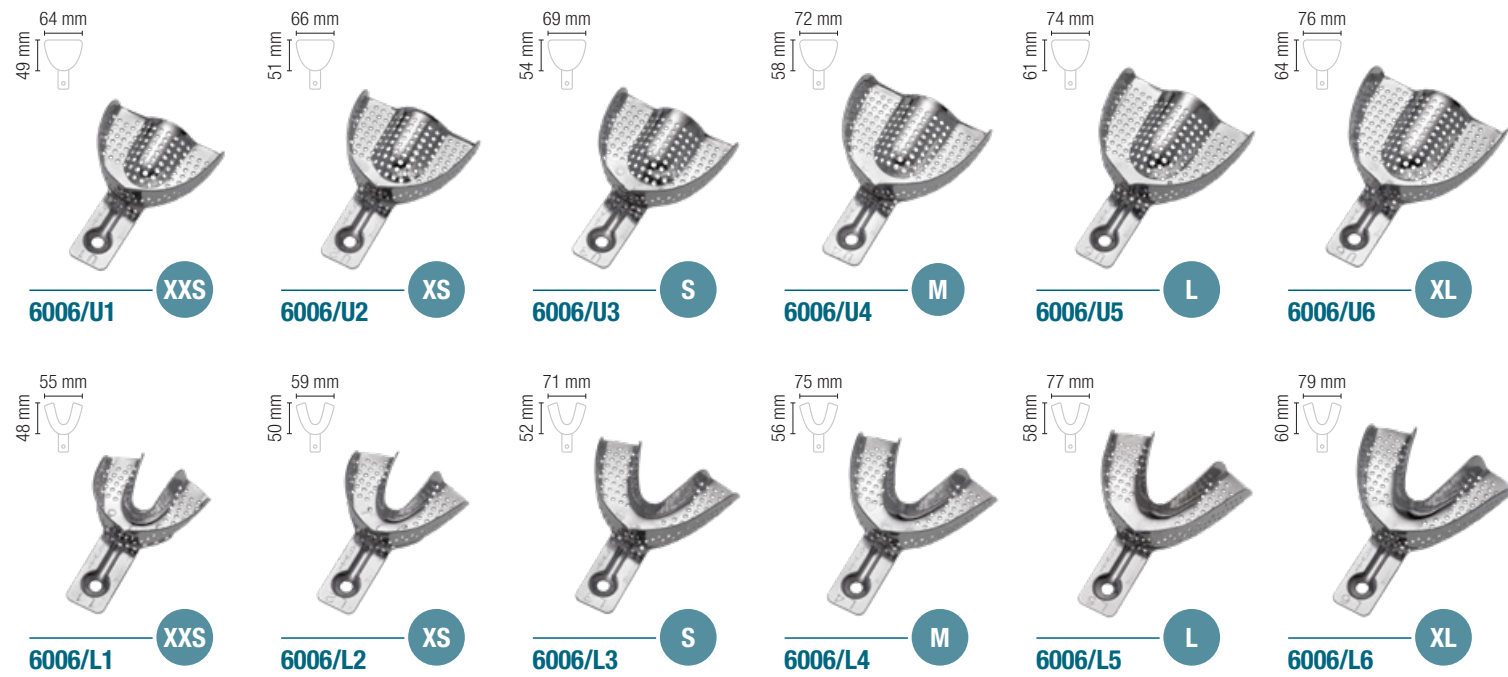

**6007/16**

Set of 16 pieces, 2 each without partials  
Confezione da 16 pezzi, 2 per tipo senza parziali

**NEWS**

**6007/24**

Set of 24 assorted pieces  
Confezione da 24 pezzi assortiti

**6007/100**

Set of 100 assorted pieces  
Confezione da 100 pezzi assortiti



BENDABLE  
PIEGHEVOLI



**6006/4 DR**  
Partial right  
Parziale destro

**6006/4 SL**  
Partial left  
Parziale sinistro



**6007/4 DR1**  
Partial right 1  
Parziale destro 1

**6007/4 SL1**  
Partial left 1  
Parziale sinistro 1

**6007/4 DR2**  
Partial right 2  
Parziale destro 2

**6007/4 SL2**  
Partial left 2  
Parziale sinistro 2





## POLYCARBONATE IMPRESSION TRAYS PORTAIMPRONTE IN POLICARBONATO



121°C  
🌡️

**AUTOCLAVABILE AT 121° C**  
AUTOCLAVABILI A 121° C

For edentulous or partially toothed bites, autoclavable (more info upon request).  
Per bocche edentule o parzialmente dentate, autoclavabile (su richiesta maggiori informazioni).

**6008/24**  
Series of 24 polycarbonate impression trays and compasses for final impressions  
Serie di 24 portaimpronte in polycarbonato più compasso per impronte definitive

**SOLDERING TWEEZERS**  
PINZETTE PER SALDATURA



**221**  
Straight  
Retta  
mm 165

**222**  
Curved  
Curva  
mm 160

Fiber handles  
Manico in fibra



**4583**  
Miller  
Articulating paper holder  
Pinze carta articolazione



**4955/S**  
Brusher  
Scovolino



**4955/A**  
Syringe for elastometers, aluminium  
Siringa per elastomeri, alluminio



**4955/P**  
Tips, spare part  
Puntali di ricambio



**574**  
Modeling knife  
Cottello per modellare

Blade to remove exceeding material.  
Lama per rimuovere il materiale in eccesso.



Mini-circular blade to trim off specific mesial and distal spots.  
Lama mini-circolare per eliminare specifici punti mesiali e distali.

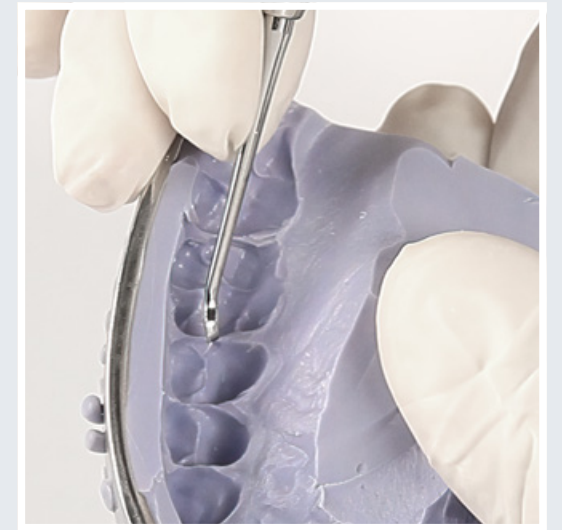

WATCH THE VIDEO ON  
YouTube MEDESY CHANNEL!

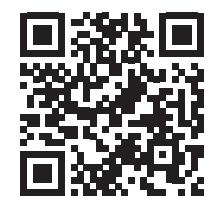

**3633/CR**  
Modeling knife  
Cottello per modellare

Fit all kind of blade #3 to remove exceeding material.  
Montare tutti i tipi di lame #3 per rimuovere il materiale in eccesso.



Mini-circular blade to trim off specific mesial and distal spots.  
Lama mini-circolare per eliminare specifici punti mesiali e distali.

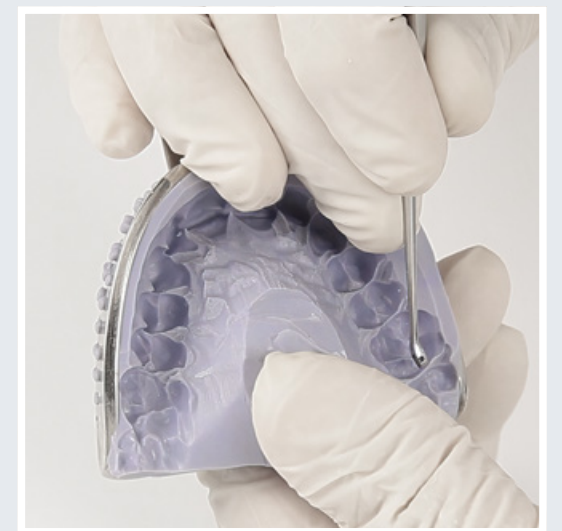

# CALIPERS

## CALIBRI



**4983**  
Beerendonk  
mm 130



**4984**  
Züricher  
mm 130



**4982**  
Boley  
mm 145



**4988**  
Steel ruler  
Righello in acciaio  
mm 180



**4980/C**  
Iwanson  
For wax  
Per cera  
mm 100



**4981/M**  
Iwanson  
For metal  
Per metallo  
mm 100

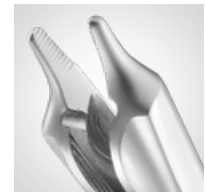

**2810**  
Universal  
Wire bending pliers  
Pinze piega fili  
mm 155