

EXPANSION SCREWS

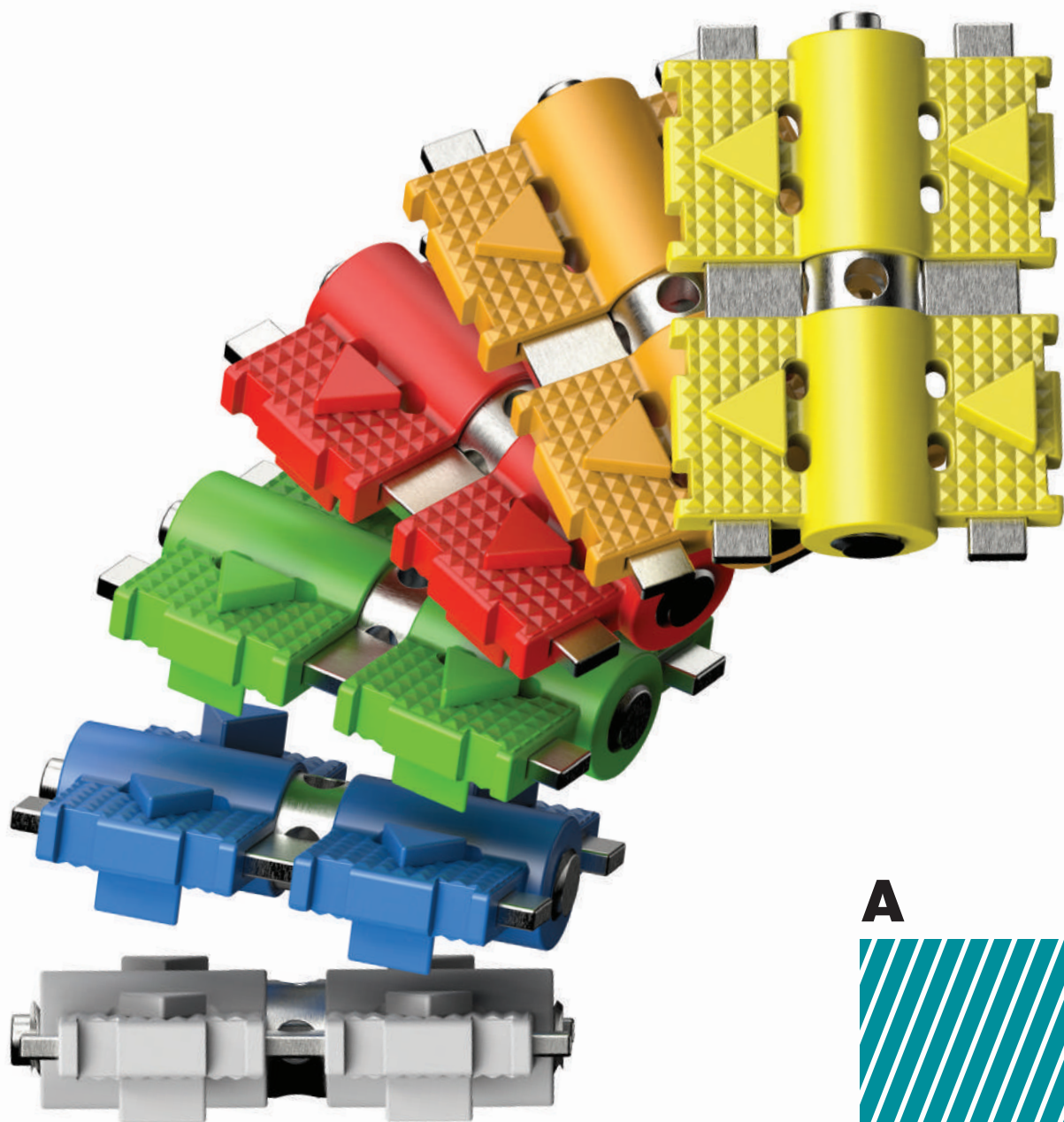

A

POP® EXPANSION SCREWS



PERFECT ORTHODONTIC PERFORMANCE

POP!

Perfect Orthodontic Performance

THE INNOVATIVE AND BIOMECHANICAL ORTHODONTIC EXPANSION SCREW *

TECHNO POLYMER

SELF-CENTERING RECTANGULAR GUIDES

EMBOSSED ARROWS

BIOMEDICAL STAINLESS STEEL

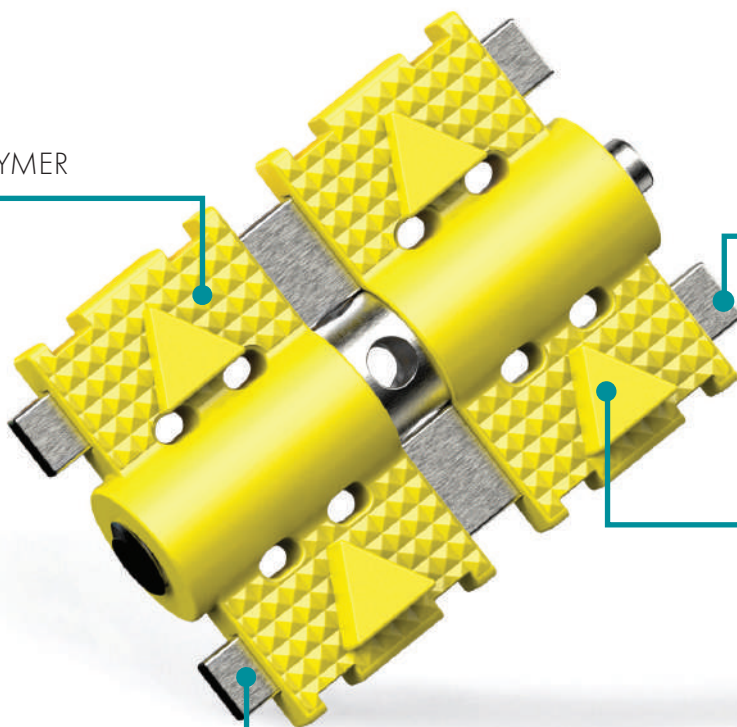

AVAILABLE IN 6 COLOURS

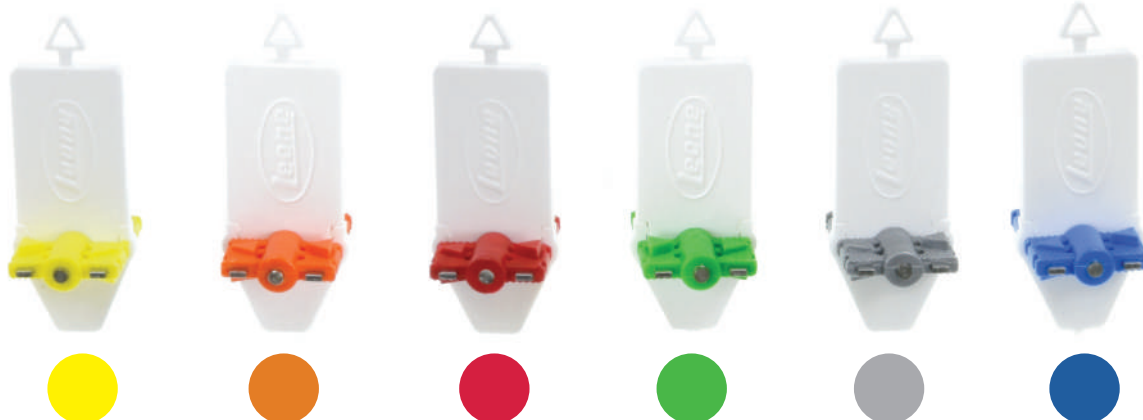

*PATENTED



- Made of stainless steel and biomedical techno polymer.
- The male screw is not in contact with the orthodontic acrylic resin: the function of the screw will not be influenced by the quality of the technical procedure and a non-compliant curing time.
- Continuous expansion movement: the high pressure injection of the polymer allows the perfect copy of the male thread of the screw, thus ensuring a steady expansion transmission without the risk of undesired turning-back in the mouth.
- The self-centering rectangular guides ensure a biomechanical and absolutely controlled symmetrical expansion.
- The flat shape of the guides and their flexibility allow the gradual release of the expansion with a physiological orthodontic movement.
- The flexibility of the screw allows the adjustments of any dental regress due to inconsistent use of the appliance by the patient, thus being very effective with holding devices following a rapid expansion treatment.
- The high adaptability of the appliance enables a comfortable application in the mouth in the days following re-activation.
- Two embossed arrows on the body indicate the direction of opening. When using a color of acrylic resin similar to the polymer body, a white arrow provided with the plastic placement tab may be easily applied to make the direction of activation visible.
- The placement plastic tab, made of two pieces, combined with a unique geometry, allows a perfect protection of the holes from the acrylic resin during the packing procedure and facilitates removal after the curing cycle.
- The screw body is available in 6 colours.



POP® EXPANSION SCREWS

PERFECT ORTHODONTIC PERFORMANCE

POP® SCREW FOR UPPER ARCH

pkg.

↑ 3,5 mm
↓ 3,5 mm
← 9,85 mm →

0,8 mm

9 mm

	yellow	orange	red	green	silver	blue		
	A4805-14G	A4805-14E	A4805-14R	A4805-14V	A4805-14T	A4805-14A	10	
ASSORTED COLOURS	x2						A4805-90	12

POP® SCREW UNIVERSAL

pkg.

↑ 3 mm
↓ 3 mm
← 8,35 mm →

0,7 mm

8 mm

	yellow	orange	red	green	silver	blue		
	A4800-12G	A4800-12E	A4800-12R	A4800-12V	A4800-12T	A4800-12A	10	
ASSORTED COLOURS	x2						A4800-90	12

POP!

Perfect Orthodontic Performance

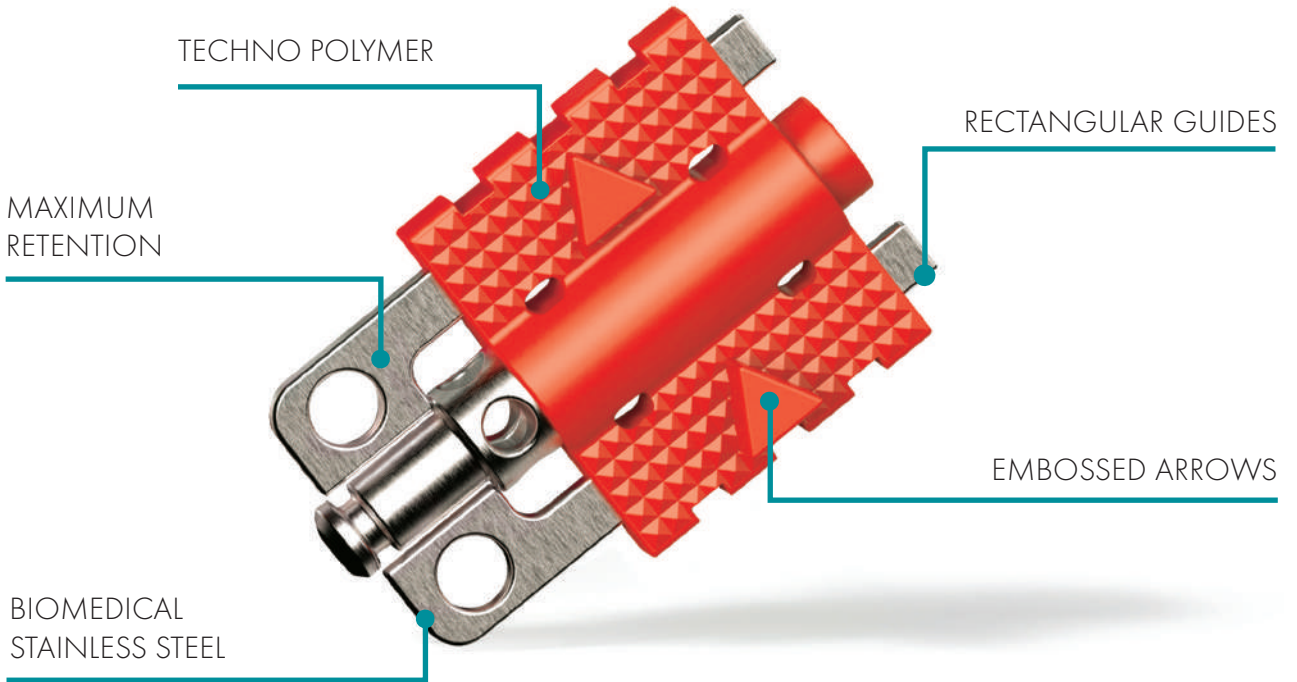

AVAILABLE IN 6 COLOURS

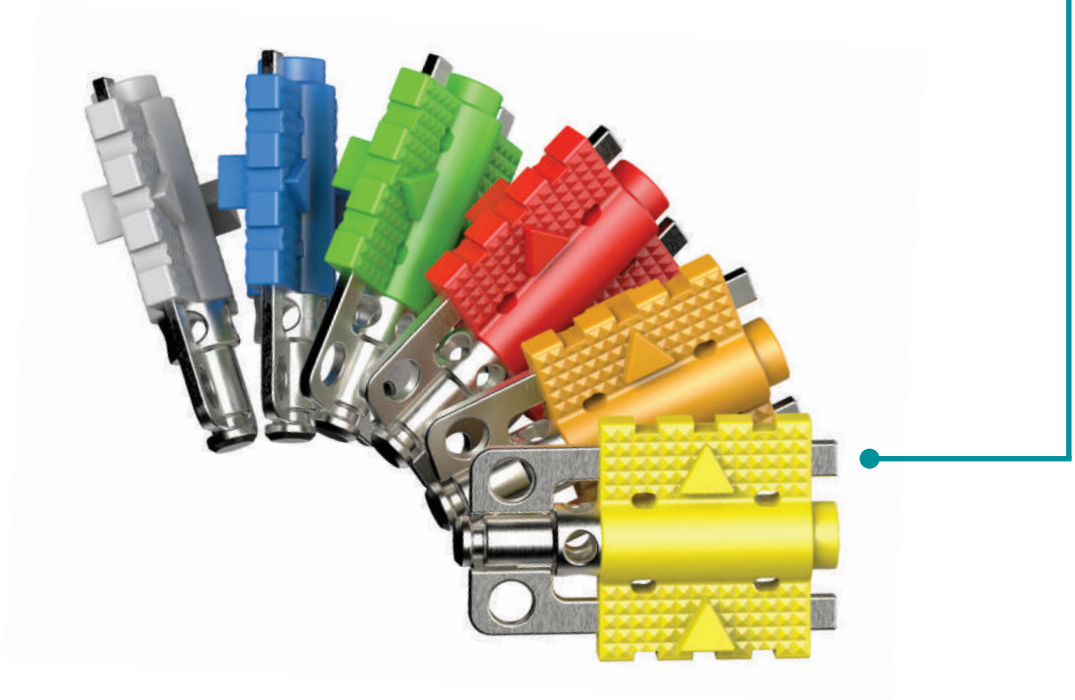



- The **POP® MICRO SECTIONAL SCREW** is added to the already known POP SCREW range to increase therapeutic options.
- Made of stainless steel and biomedical techno polymer.
- The male screw is not in contact with the orthodontic acrylic resin: its functionality will not be influenced by the quality of the technical procedure and/or of non-compliant curing time.
- Continuous expansion movement: the high pressure injection of the polymer allows the perfect copy of the male screw thread thus, ensuring a steady expansion transmission without the risk of undesired turning-back into the mouth.
- The flat shape of the guides and their flexibility allow a more gradual deliver of the expansion forces for a physiological orthodontic movement.
- The metallic anchorage side of the screw has two through-holes in order to increase retention into the acrylic.
- The flexibility of the screw could compensate slight relapse due to inconsistent use of the appliance by the patient.
- The high adaptability of the appliance enables a comfortable application into the mouth even in the days following re-activation.
- Two embossed arrows on the body indicate the direction of opening. When using a color of acrylic resin similar to the polymer body, a white arrow provided with the plastic placement tab may be easily snapped on to make the direction of activation more visible.
- Available in 6 colors.



POP® MICRO SECTIONAL SCREW

						↻	↔	pkg.	
yellow	orange	red	green	silver	blue				
A4801-00G	A4801-00E	A4801-00R	A4801-00V	A4801-00T	A4801-00A			10	
ASSORTED COLOURS							x2	A4801-90	12

The Leone expansion screws for removable orthodontic appliances derive from 80 years of extensive research, design and millions of clinical cases. The entire production process takes place in Italy with computer aided and automated machines. The screws are made of biomedical stainless steel of the highest quality and male screw threads with centesimal tolerances and total absence of surface roughness. The bodies and guides are made with tolerances of ± 0.01 mm which ensure stability and precision. The wide range available allows the production of any type of removable device.

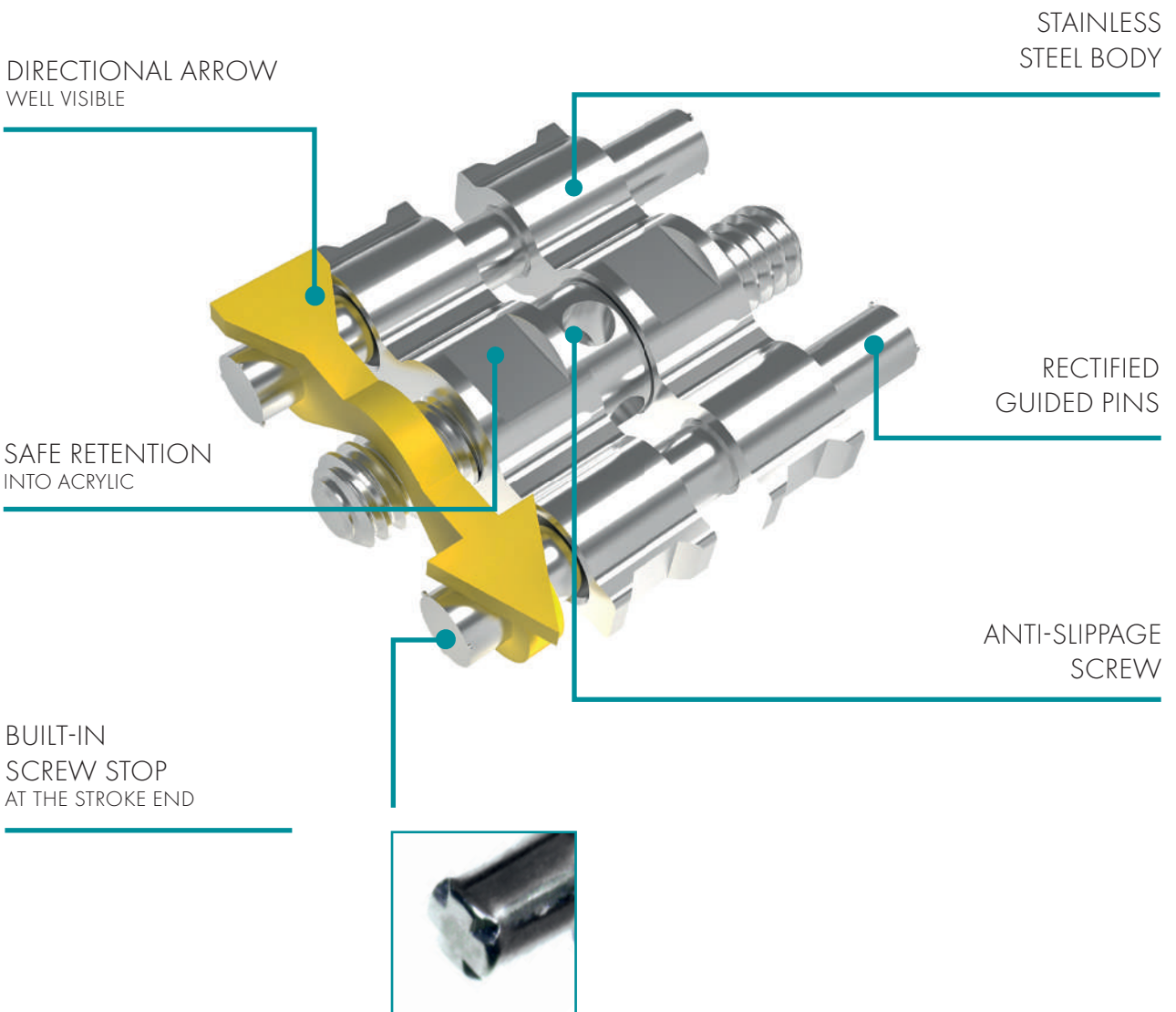

STANDARD SCREW FOR UPPER APPLIANCES

								pkg.
				0,8 mm	7 mm	A0805-111	1	
						A0805-11	10	
						A0805-95	100	
				0,8 mm	9 mm	A0805-141	1	
						A0805-14	10	
						A0805-96	100	

MEDIUM SCREW

								pkg.
				0,8 mm	7 mm	A0803-11	10	
						A0803-95	100	
						A0803-14	10	
				0,8 mm	9 mm	A0803-96	100	

UNIVERSAL SCREW

								pkg.
				0,7 mm	6 mm	A0800-10	10	
						A0800-95	100	
						A0800-12	10	
				0,7 mm	8 mm	A0800-96	100	

SUPER MICRO SCREW

								pkg.
				0,7 mm	6 mm	A0890-111	1	
						A0890-11	10	
						A0890-95	100	

SUPER MICRO SECTIONAL SCREW



					pkg.
 ← 9 mm →	 2.5 mm 4.6 mm	0,35 mm	3 mm	A0891-09	10
				A0891-95	100
 ← 10 mm →	 2.5 mm 4.6 mm	0,35 mm	3 mm	A0891-10	10
				A0891-96	100



MICRO SECTIONAL SCREW WITH BENT U-SHAPED GUIDE PIN



					pkg.
 ← 13 mm →	 3 mm 7,25 mm	0,4 mm	4 mm	A0802-00	10
				A0802-95	100
 ← 13 mm →	 3 mm 7,25 mm	0,4 mm	4 mm	A0802-13	10
				A0802-96	100



MICRO SECTIONAL SCREW WITH STRAIGHT U-SHAPED GUIDE PIN



					pkg.
 ← 12 mm →	 3 mm 7,25 mm	0,4 mm	4 mm	A0801-12	10
				A0801-96	100
 ← 14 mm →	 3 mm 7,25 mm	0,4 mm	6 mm	A0801-13	10
				A0801-98	100
 ← 14 mm →	 3 mm 7,25 mm	0,4 mm	4 mm	A0801-14	10
				A0801-97	100



MICRO SECTIONAL SCREW

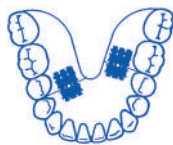

					pkg.
 ← 10 mm →	 3 mm 7,25 mm	0,4 mm	4 mm	A0801-10	10
				A0801-95	100
 ← 12 mm →	 3 mm 7,25 mm	0,4 mm	6 mm	A0801-00	10
				A0801-99	100





The assortment of special expansion screws proposed by Leone derives from over 30 years experience in the manufacture of expansion screws. Screw selection ranges from the Pagani classical fan-type screw, to the Bertoni three directional ones, up to the kit for construction of the Twin Wing class II corrector. The special purpose expansion screws are made of biomedical stainless steel with a mechanical tolerance superior to 1/100 mm. The thread parts are absolutely smooth and ensure great sturdiness, good friction and prevent any unwanted turning-back.

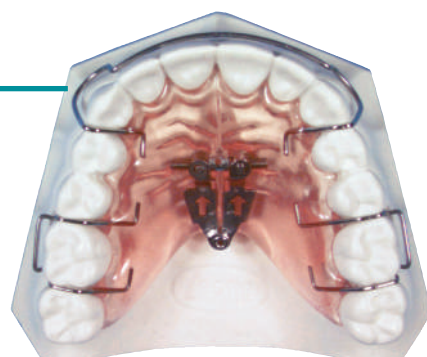
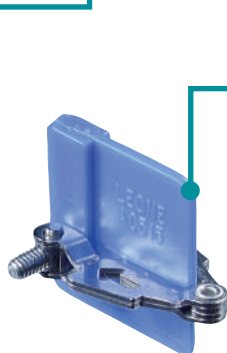
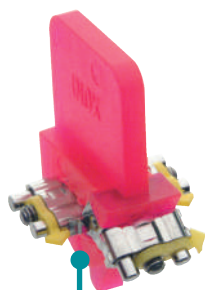

THREE DIRECTIONAL SCREW ANATOMICAL

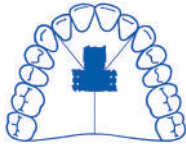
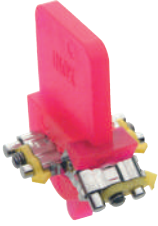

3 activation points

					pkg.
		0,4 mm	3 mm	A0930-14	1
			3 mm 3 mm	A0930-93	5
← 14 mm →					
		0,4 mm	4 mm	A0930-16	1
			4 mm 4 mm	A0930-94	5
← 16 mm →					



THREE DIRECTIONAL SCREW ANATOMICAL

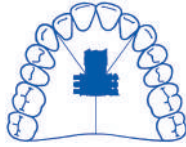

2 activation points

					pkg.
		0,4 mm protrusive	3 mm	A0931-14	1
		0,8 mm transversal	6 mm	A0931-93	5
← 14 mm →					
		0,4 mm protrusive	4 mm	A0931-16	1
		0,8 mm transversal	8 mm	A0931-94	5
← 16 mm →					



THREE DIRECTIONAL SCREW ANATOMICAL FOR LOWER ARCH



2 activation points

					pkg.
		0,4 mm protrusive	2,5 mm	A0932-13	1
		0,8 mm transversal	4 mm	A0932-93	5
← 13 mm →					



TRAPEZOIDAL SCREW

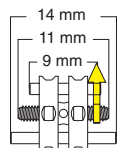

0,8 mm

5 mm

A0813-00 10

A0813-95 100



FAN-TYPE SCREW

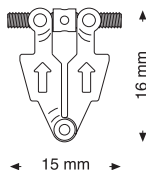

0,8 mm 9 mm

pkg.

A0515-14 1

A0515-95 100



ASYMMETRIC FAN-TYPE SCREW



0,8 mm 9 mm

pkg.

A0516-14 1

A0516-95 100



FAN-TYPE SCREW 2 PIECES

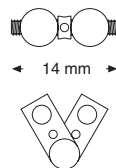

0,8 mm 9 mm

pkg.

A0815-14 1

A0815-95 100



MANDIBULAR BOW SCREW

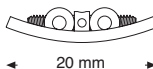

0,8 mm 5 mm

pkg.

A0517-25 1

A0517-95 100



BI-FAN-TYPE SCREW

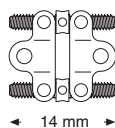

0,8 mm 9 mm

pkg.

A0518-14 1

A0518-95 100



TWIN WING

CLASS II CORRECTOR KIT



A0840-05 1 appliance

Thanks to our experience gained with MAD appliances and based on the fundamentals of the most widely used orthodontic appliance for the treatment of Class II patients with mandibular retraction, we have miniaturized and reengineered the Forward! to manufacture the Twin Wing.

The kit, especially designed for the realization of this innovative appliance, contains all the components for an easier and more precise construction.

The appliance, thanks to the 70° inclination between the upper screws and the lower wings, is scientifically and clinically proven as the most efficient for the stimulation of mandibular growth and allows the millimetric advancement of the lower jaw.

Moreover, in case of a deep bite, since the occlusal surface can be kept free from the presence of block, it is possible to exclude some teeth from contact with the acrylic, promoting a guided extrusion and consequently, the resolution of vertical problems.

The kit for the construction of 1 appliance includes:

- 2 upper screws, 1 right and 1 left
- 2 lower wings with steel frames, 1 right and 1 left

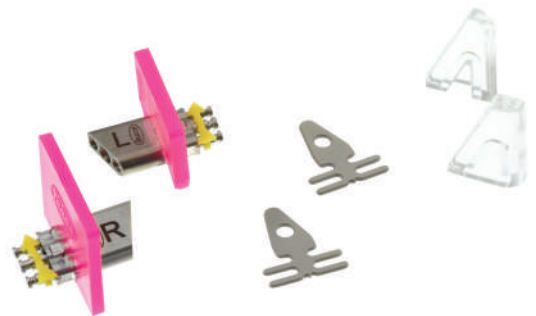
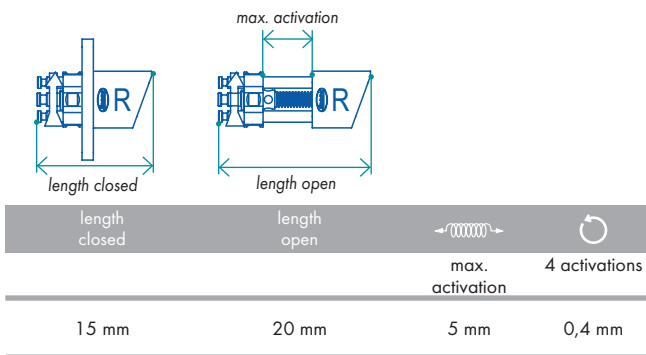

REFILLS FOR TWIN WING

A0841-00

Lower wings with inner steel frame



Pack content:

- 1 lower right wing with steel frame
- 1 lower left wing with steel frame



Leone palatal expanders have been known worldwide for more than 50 years and they're now the most complete range of expanders in the market. The 620 series is a superior product made in various dimensions with many advanced features including laser welding of the extension arms into the body of the expander for greater strength and stability. The automated manufacturing process and quality control with the highest standards allow us to confidently say that we are offering the best palatal expanders in the world today.

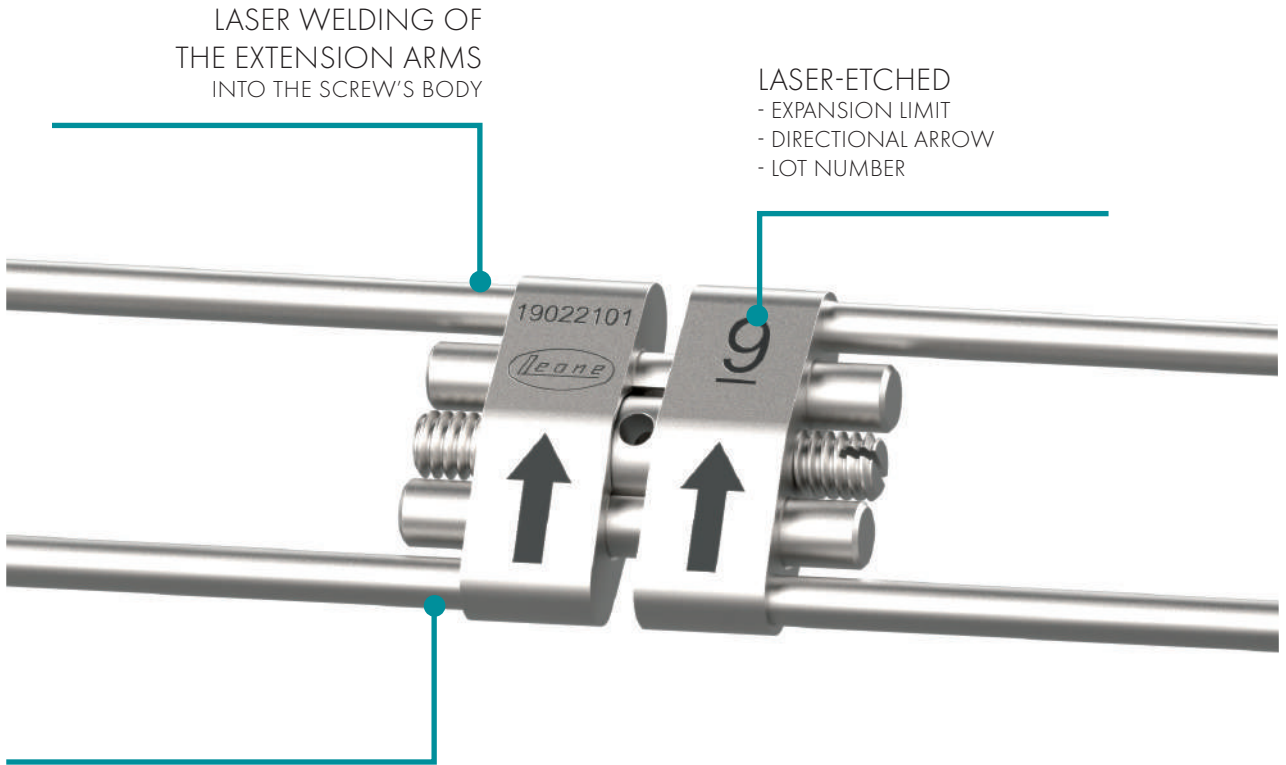

MADE ENTIRELY OF BIOMEDICAL STAINLESS STEEL



SWIVEL KEY
ALSO AVAILABLE WITH ACTIVATION TURN COUNTER

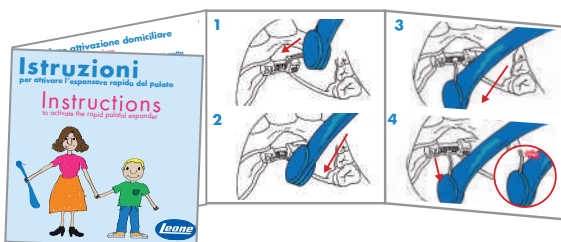

INSTRUCTIONS FOR USE OF EXPANDERS
USEFUL FOR PARENTS AND DOCTOR



RAPID EXPANDER
The best-selling palatal expander in the world





Made entirely of biomedical stainless steel. The housing design is completely smooth, with no rough areas for a secure hygiene. The expander limit, a directional arrow and the lot number are laser etched into the surface of the expander's body. Supplied with a swivel key with handle and instructions for use to facilitate the patient endoral activation. The arm bending and self-locking instrument REF P0620-00 (page 31) is also available.

Pack of 1

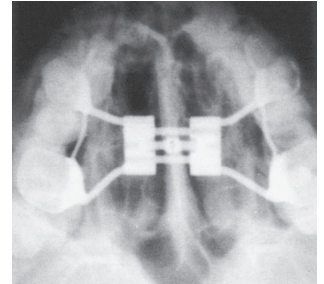

Swivel key included in the package



	11 mm	4 mm	∅ arms	↔ body	↻	activation turns for maximum expansion limit	
			1,5 mm	12 mm	8 mm	0,8 mm	35
			1,5 mm	14 mm	9 mm	0,8 mm	40
			1,5 mm	16 mm	11 mm	0,8 mm	50
			1,5 mm	18 mm	13 mm	0,8 mm	60
			1,5 mm	20 mm	15 mm	0,8 mm	70



A0600-00
PROTECTIVE TAB * FOR HAAS-STYLE PALATAL EXPANDER

Made of two parts for safe and easy protection of the activation holes from resin for rapid expanders A0620 type and the realization of expanders with palatal acrylic plate.

Pack of 10



1 Unlock the expander with 1 activation hole and fit the bottom into the space between the two bodies, then lock the expander again.



3 Simply apply the upper part of the tab which is shaped to cover and protect the holes on screw's head from acrylic.



4 Once embedded into the acrylic plate, remove the top of the tab and, after cutting the resin, unlock the expander for some holes, and the rear part will also be easily removed.

*PATENTED



**RAPID EXPANDER
WITH PRE-BENT ARMS**

Exactly the same as A0620 expander for all technical features and materials used, but designed with pre-bent arms to facilitate the work in the laboratory. The front arms are more inclined than the rear arms to allow the positioning of the expander's body in the most comfortable way for the patient with the best biomechanical results. Provided with one swivel key with handle and instructions for use to facilitate the patient endoral activation.

Pack of 1



Swivel key included in the package

						activation turns for maximum expansion limit
11 mm	4 mm	arms	body			
		1,5 mm	12 mm	8 mm	0,8 mm	35
A0620W08						
		1,5 mm	14 mm	9 mm	0,8 mm	40
A0620W09						
		1,5 mm	16 mm	11 mm	0,8 mm	50
A0620W11						
		1,5 mm	18 mm	13 mm	0,8 mm	60
A0620W13						

RAPID EXPANDER WITH TELESCOPIC GUIDES











The innovative telescopic guides assure a constant friction throughout the expansion movement, perfect stability and small sizes. It self-deactivates when maximum expansion capacity has been achieved, preventing overtreatment. The 7 mm expander is ideal to treat very narrow palates. The expanders with 10 and 12 mm sizes feature a compact design for ease of arm bending and reducing the overall dimensions of the device. Supplied with a swivel key with handle and instructions for use to facilitate patient endoral activation. The arm bending and self-locking instrument REF P0620-00 (page 31) is also available.

Pack of 1



Swivel key included in the package

							activation turns for maximum expansion limit
	11 mm	4 mm	1,5 mm	11 mm	7 mm	0,8 mm	35
			1,5 mm	14 mm	10 mm	0,8 mm	50
			1,5 mm	16 mm	12 mm	0,8 mm	60

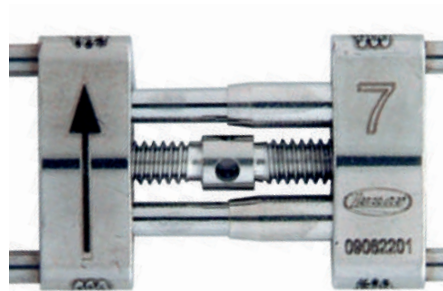

TELESCOPIC GUIDE PINS
AVOID THE POSSIBILITY OF SPONTANEOUS DEACTIVATION IN THE MOUTH

MICRO EXPANDER



Featured by a significantly smaller body bulk than other competing expanders. It features two extra-long arms also performing support for anteriors and ensuring excellent stability and comfort for the patient. The micro expander can also be used for the expansion of the lower jaw. Provided with one swivel key with handle and instructions for use to facilitate the patient endoral activation.

The arm bending and self-locking instrument REF P0621-00 (page 31) is also available.

Pack of 1



Swivel key included in the package

LOWER ARCH EXPANSION











ARM LENGTH
68 MM



- It can be positioned in the standard way, i.e. with the markings of the arrow and maximum expansion visible;

- or it can also be positioned upside down with the two arrows visible, in case of very narrow palates, to minimize the bulkiness of the arms once they are bent.

						activation turns		
4,95 mm	4,05 mm	arms 1,5 mm	0,8 mm	body mm		for maximum expansion limit		
						12	8	35
A0621-08								
						16	11	50
A0621-11								

EASY ACCESS MICRO EXPANDER FOR PALATAL SUTURE

A1621 expander called "Easy Access" is comparable to the existing A0621, but once placed in the device, the body of the screw will remain closer to the palate with minimized overall dimensions; the head with activation holes remains in front position respect to the guide pin for easier activation with the key. Provided with one swivel key with handle and instructions for use to facilitate the patient endoral activation. The arm bending and self-locking instrument REF P0621-00 (page 31) is also available.

Pack of 1



Swivel key included in the package









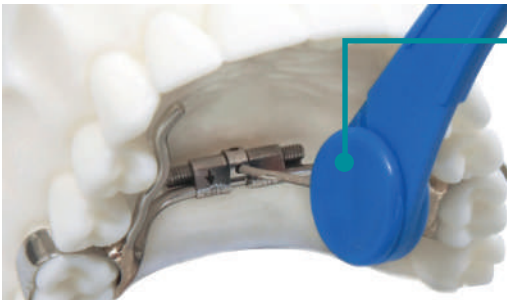

ANTERIOR POSITION HOLES OF ACTIVATION



EASY ACCESS FOR KEY ACTIVATION



3 EXPANSION VALUE FOR ANY THERAPEUTIC TREATMENT

						activation turns
4,95 mm	4,05 mm	arms 1,5 mm	0,8 mm	body mm		for maximum expansion limit
				12	8	35
				16	11	50
				18	13	60

**RAGNO FAN-TYPE
RAPID EXPANDER AND MINI RAPID EXPANDER ***

Conceived with the cooperation of Dr. Eleonora Schellino and Prof. Remo Modica

Made entirely of biomedical stainless steel. The expanding arms are laser welded to the screw body. Laser engraved directional arrows on the **MIM**® body. It is a device for the rapid expansion of the palate that allows you to get a widening of the single anterior sector of the maxillary arch still maintaining minimum expansion in the posterior sector. It self-deactivates when maximum expansion capacity has been achieved, preventing overtreatment. The difference between the two models is the geometric shape of the front part: A0625-07 is designed to be placed as high as possible in the palate vault thus ensuring the minimum bulkiness achievable. The overall size is approximately 20-25% less than the 9 mm version. Provided with one swivel key with handle and instructions for use to facilitate the patient endoral activation.

The arm bending and self-locking instruments REF P0625-09 for expander A0625-09 and REF P0625-07 for A0625-07 mini expander (page 31) are also available.

Pack of 1

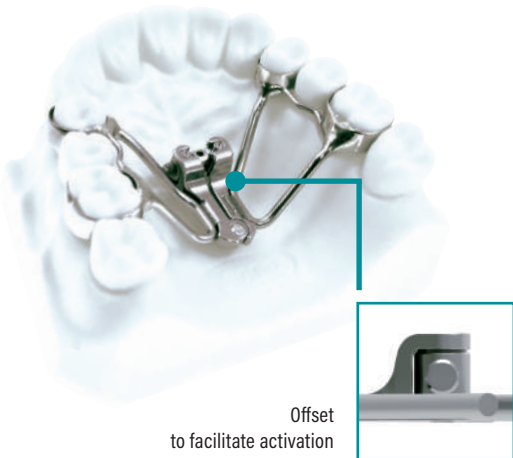

Swivel key included in the package

**COMPARISON BETWEEN
A0625-09 AND A0625-07**

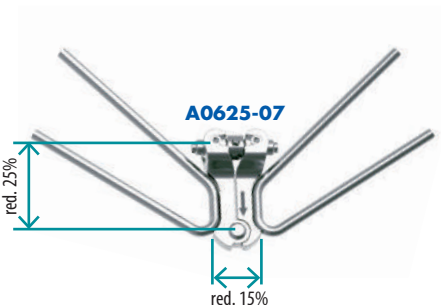

			activation turns for maximum expansion limit
--	---	---	--

A0625-09	9 mm	0,9 mm	40
-----------------	------	--------	----

			activation turns for maximum expansion limit
--	---	---	--

A0625-07	7 mm	0,9 mm	31
-----------------	------	--------	----

*PATENTED

IT ALLOWS THE MANUFACTURING OF TOTALLY CUSTOMIZED EXPANDERS BOTH HYBRID (TEETH AND TADs) AND FULLY BONE BORNE



It features two posterior arms, and, in the package, 4 dedicated TAD attachments are included that can be adapted to patient's anatomy and welded by the lab on the body of the screw. The enhanced strength of the expander ensures high mechanical resistance to apply high forces necessary for MARPE therapy (mini-screw assisted rapid palatal expander) even in adult patients. Thanks to the adaptable TADs attachments, it is possible to highly customize the rapid palatal expander on each patient anatomy, both in TADs-first and in TADs-last approach. Therefore an optimized expansion load distribution on the TADs can be achieved.

Pack content:

- 4 attachments for TAD
 - 1 stainless steel wrench
 - 1 strengthened swivel key with handle
 - instructions for the patient to facilitate endoral activation at home
- Available dedicated instrument for TADs attachment customization.

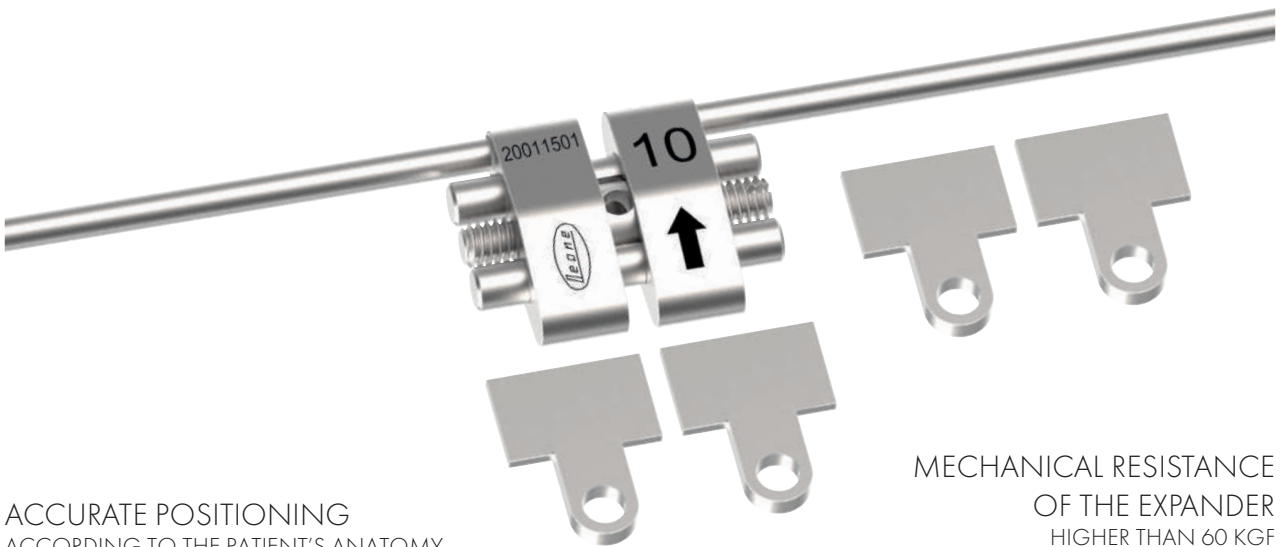

ACCURATE POSITIONING
ACCORDING TO THE PATIENT'S ANATOMY AND ORIENTATION OF THE TADs ATTACHMENTS BASED ON THE POSITION OF THE TADs

MECHANICAL RESISTANCE
OF THE EXPANDER
HIGHER THAN 60 KGF

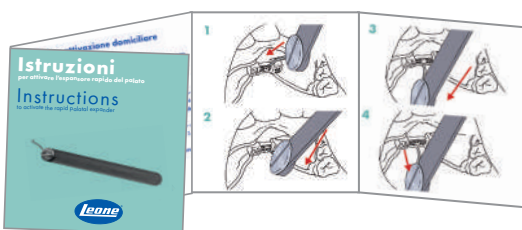











INSTRUCTIONS TO ACTIVATE THE EXPANDER
USEFUL FOR PARENTS AND CLINICIANS

STRENGTHENED SWIVEL KEY

THE INTRAORAL ACTIVATION KEY DEDICATED TO THESE EXPANDERS AND SUPPLIED INSIDE THE PACKAGE, IS CHARACTERIZED BY A HIGH RESISTANCE AND ITS USE IS MANDATORY TO ALLOW THE FULL TRANSMISSION OF THE EXPANSIVE FORCE

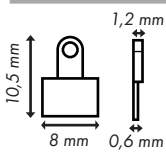
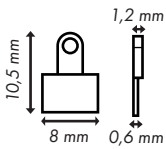



							activation turns	
	11 mm	4 mm	arms	body			for maximum expansion limit	
	201A0620-08	1,5 mm	12 mm	8 mm	0,8 mm	40		
	201A0620-10	1,5 mm	15 mm	10 mm	0,8 mm	50		
	201A0620-12	1,5 mm	17 mm	12 mm	0,8 mm	60		 Ø hole 2,2mm

Pack of 1 expander and 4 attachments

P0201-00
BENDING INSTRUMENT
FOR TADs ATTACHMENTS

Made by two elements, it is used to easily adapt the TADs attachments to every anatomical and treatment needed. Both components are made of stainless steel and laser marked.



LEAF EXPANDER® **MEMORIA® LEAF SPRING ACTIVATED EXPANDER***



This device is an evolution in the design of the previous spring-loaded expander, designed with technical and scientific collaboration of Dr. Claudio Lanteri and Mr. Filippo Francolini. This new expander features a small size body, and is equipped with two Nickel Titanium **MEMORIA®** leaf springs, allowing the release of calibrated and continuous force to promote the expansion of the maxillary arch. Re-loading is needed when the two opposing leaf springs move apart: the endoral activation, which must be done in the dental office, will put the springs in contact again thus allowing the release of the selected force. The expander is available in two models, 450 g and 900 g and each one of these is available in two expansion capacities, 6 mm and 9 mm. The expander is supplied with the leaf springs (2 or 3 according to the size) ready-compressed by two metal staples that the technician will remove after the construction of the device. The package includes a special clip with safety leash to keep the leaf springs compressed, facilitating the technician and the clinician in specific phases of realization and treatment. Inside the package is also available practical instructions for use where all the construction steps and methods of delivery are illustrated.



Swivel key and clip included in the package

Supplied with a swivel key with handle to facilitate the endoral activation by the professional.

Pack of 1

ok ORTHODONTICS FOR KIDS

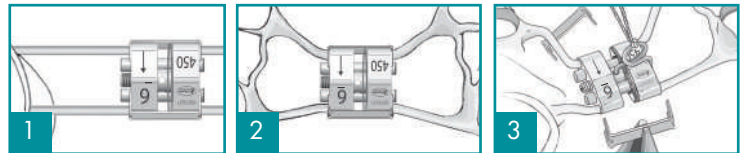

	11 mm	4 mm	arms	body		activation turns for maximum expansion limit
A2703-06 2 springs 450 g approx.			1,5 mm	12 mm	6 mm	30
A2704-06 2 springs 900 g approx.						
A2703-09 3 springs 450 g approx.			1,5 mm	16 mm	9 mm	45
A2704-09 3 springs 900 g approx.						

INTRA-ORAL UTILIZATION CHART

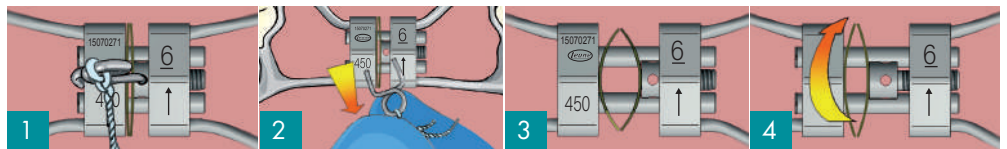

ACTIVATION PROTOCOL	LEAF expander cementation	FIRST phase	SECOND phase	THIRD phase
6 mm A2703-06 A2704-06	spring activation 0 turns	10 turns	10 turns	10 turns
9 mm A2703-09 A2704-09	spring activation 0 turns	15 turns	15 turns	15 turns

*PATENTED



A2700-00
EXPANSION MEASURING GAUGE
FOR LEAF EXPANDER *

Helpful to verify the expansion gained and the need to activate the expander or compress the springs again. Easy to place design, it makes it easier to check the expansion value directly into the mouth.

Made of steel, suitable for hot and cold sterilization.

Pack of 1



MEMORIA®
LEAF SPRING
SELF-ACTIVATED
EXPANDER *

It includes all advantages of the Leaf expander without the need for periodic reactivation. The effectiveness of this expander is based entirely on the elastic capacity of the leaf springs made of Nickel Titanium that release controlled and continuous forces. The choice of the expander is decided on the basis of the transversal discrepancy of the patient: the therapy is predetermined and does not require any further action either by the clinician nor patient.

The expander is available in two models, 450 g and 900 g and each one of these is available in two expansion capacities: 6 mm (four leaf springs) and 9 mm (six leaf springs). The expander is supplied with leaf springs ready-compressed by two metal staples that the technician will remove after the construction of the device. The package includes a special clip with a safety leash to keep the leaf springs compressed, facilitating the technician and the clinician in specific phases of realization and treatment.

Inside the package is also available practical instructions for use where all the construction steps and methods of delivery are illustrated.

Pack of 1

ok ORTHODONTICS
FOR KIDS

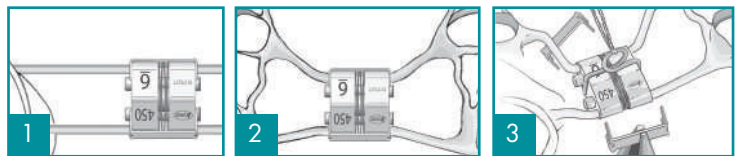
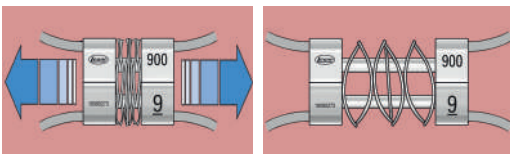

	11 mm	4 mm	∅	↔	↔
			arms	body	
A2705-06					
4 springs					
450 g approx.			1,5 mm	11 mm	6 mm
A2706-06					
4 springs					
900 g approx.					
A2705-09					
6 springs					
450 g approx.			1,5 mm	15 mm	9 mm
A2706-09					
6 springs					
900 g approx.					

*PATENTED



Swivel key included in the package

BABY RPE EXPANSION SCREW*

Developed with the assistance and clinical experience of Prof. Nicola Veltri, the RPE baby expansion screw is intended for the rapid expansion of the palate suture, and is available with either 2 or 4 arms. The model with 4 arms may be an alternative to the expander A0620, while the model with 2 arms may be an alternative to the expander A0621.

Supplied with a swivel key with handle and instructions for use to facilitate the patient endoral activation.

Pack of 1

						activation turns for maximum expansion limit
--	--	--	--	--	--	--

	16 mm	11	0,8 mm	50
--	-------	----	--------	----

A3620-11

						activation turns for maximum expansion limit
--	--	--	--	--	--	--

	16 mm	11	0,8 mm	50
--	-------	----	--------	----

A3621-11

MULTIFUNCTIONAL ORTHODONTIC SCREWS*

Intended for unilateral distalization and expansion of upper molars. Available with 3 or 4 arms. Featuring one guide only and expansion capacity up to 11 mm.

Pack of 1

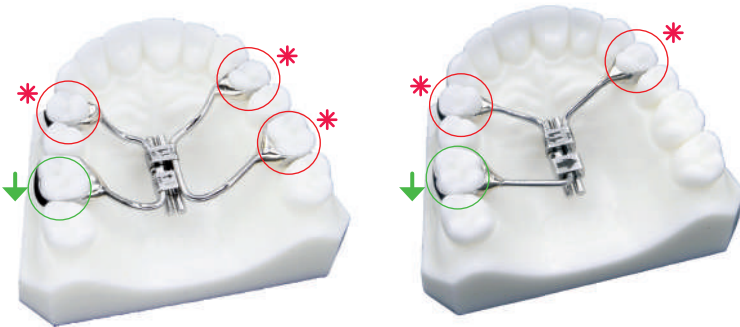

* ANCHORAGE
 ↓ EXPECTED DENTAL MOVEMENT



Key with safety ring leash included in the package

						activation turns for maximum expansion limit
--	--	--	--	--	--	--

	16	11	0,8 mm	50
--	----	----	--------	----

A3626-11

	16	11	0,8 mm	50
--	----	----	--------	----

A3628-11

	16	11	0,8 mm	50
--	----	----	--------	----

A3629-11

L

*PATENTED



ARM BENDING AND SELF-LOCKING INSTRUMENT* FOR EXPANDERS

Handy instrument to firmly hold the expander; it allows for easy and accurate modeling of the arms along with the special arm bending tool P1620-02 (page 35). The instrument ends with a clutch mechanism that is shaped on the model of expander to avoid damage to the bodies and kept closed by a cursor clamp device that is turned on and off with a simple thumb action. The edge thickness of the clutching mechanism ends is designed to indicate the minimum space between the body of the expander and the palatal vault. By placing the instrument with the screw on the plaster model, the correct inclination and the right height to bend the arms will be clearly visible. It is also useful to test the expander prior to use by opening and closing the expander with the special straight key.

for expanders		
	P0620-00	A0620-08/09/11/13/15 A2620-07/10/12
	P0630-00	A0631-08/10/12
	P0621-00	A0621-08/11 A1621-08/11/13
	P0625-09	A0625-09
	P0625-07	A0625-07

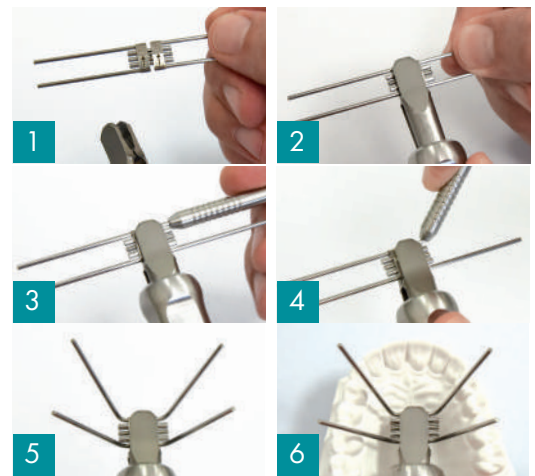

A0558-01 SWIVEL KEY WITH ACTIVATION TURN COUNTER *



The A0558-01 key is characterized by a "click" after each activation turn which can be heard by the user to control the activation turns of the expander in the oral cavity. A counter on the rear part of the handle enables the easy activation turn control by the patient.

Pack of 10

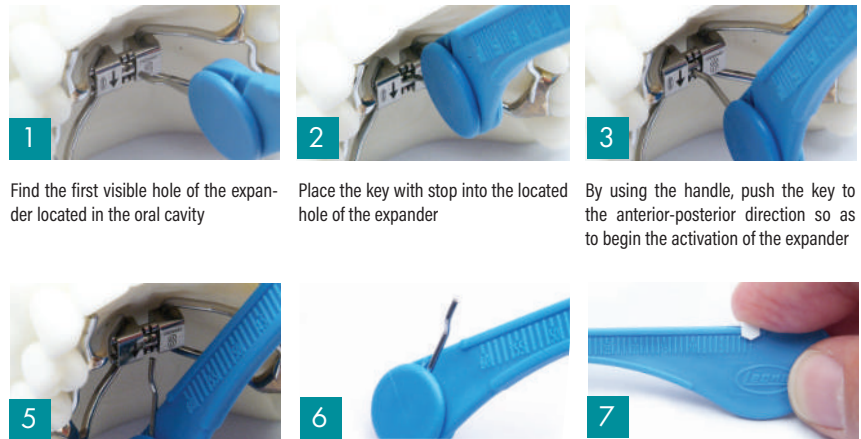

The activation ends when a "click" is detected by the key that exceeds the offset limit on the circular end of the handle (1 click equals 1/4 turn)

Pull the key out of the hole when the activation is completed

Check that the key has reached the stop on the circular end of the handle

Place the tip of the white turn counter on the line corresponding to the number of turn activations done

*PATENTED

RAPID MOLAR DISTALIZER



A1730-91
1 case

A1730-99
10 cases









Leone First Class is the perfect appliance to get a rapid controlled distalization of the upper molars; conceived with the technical and scientific cooperation of Drs. Arturo Fortini, Massimo Lupoli and Mr. Massimiliano Parri. The vestibular and lingual tubes are made with **MIM**® technology for maximum comfort and precision. The bicuspid tube is a little higher to compensate non-perfect alignment of molars that may be found in some patients. One turn a day activation produces a distal movement of 0,1 mm sufficient to get molar distalization with a minimum loss of anchorage. The package is supplied with all the components necessary for the construction of the appliance.



Key with safety ring leash included in the package

REFILLS FOR FIRST CLASS LEONE

Pack of 10

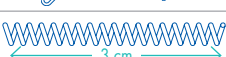
			content of 1 case kit
Male screws		A1730-01	2
Threaded tubes		A1730-02	2
MIM ® vestibular tubes		A1730-03	2
MIM ® palatal tubes		A1730-04	2
MIM ® vestibular tubes, high		A1730-05	2
Fixing rings		A1730-06	4
Palatal wires		A1730-07	2
Keys		A1730-08	1
MEMORIA ® springs		A1730-09	2

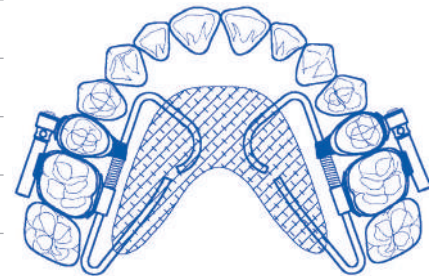

P1730-91 PARALLELING DEVICE FOR FIRST CLASS LEONE

Specific device for the visualization and the maintenance of a parallel position between the vestibular screw and the lingual bar during soldering.

Pack content: 2 paralleling male screws, 2 paralleling devices and instructions for use

FAST BACK
Leone

**FAST BACK LEONE
DISTALIZER**

A1760-91 1 case



Fast Back is a device for the distalization of upper molars, developed through the cooperation of Dr. C. Lanteri and Mr. F. Francolini. The Fast Back device provides a translation movement of the molars using a pre-determined amount of pressure. There is no need for the cooperation of the patient thus maintaining a good anchorage control. The principle of the Fast Back distalization process is based on the compression of a **MEMORIA®** coil spring, available in 200 g and 300 g, which exerts a constant force on the molar. The spring can be re-activated each month through the expansion of the screws in the device. The tube, pre welded on the molar band, enables the screw arm to slide smoothly with total control of the direction of distalisation. The Fast Back kit contains all the elements needed for the construction of a bilateral Fast Back device.



Key with safety ring leash included in the package

REFILL FOR FAST BACK LEONE

		activation turns for maximum expansion limit		pkg.
Distalizer 9 mm UR		40	0,8 mm	A1760-09
Distalizer 9 mm UL				A1761-09
MIM® palatal tubes		A1730-04		
Spherical ends		A1763-00		
Ends with hole for ligature		A1763-05		
Spring-compression stop		A1763-01		pack of 10
MEMORIA® coil spring 200 g		A1763-02		
MEMORIA® coil spring 300 g		A1763-03		
Keys		A1763-04		

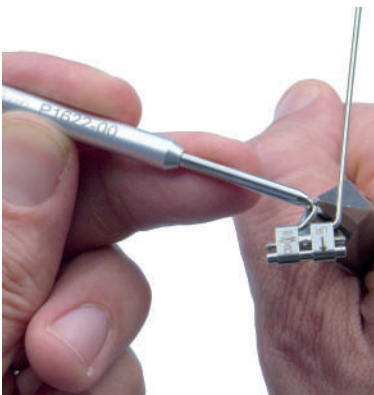
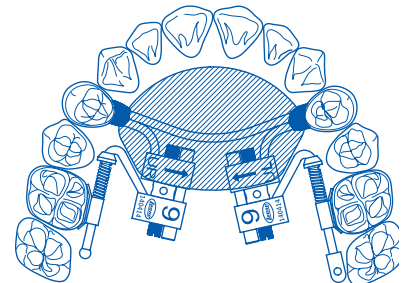

**P1622-00
ARM BENDING INSTRUMENT
FOR FAST BACK**

It facilitates the job of the technician during the construction of the device. It allows to maintain the linearity of the arm which has to slide on the palatal tube. The aluminium handle joined to the tempered steel tube assures a firm grip to get accurate bends.



A0558-00
EXPANSION
SWIVEL KEY

Pack of 10



P1620-02
ARM BENDING INSTRUMENT
FOR EXPANDERS

Ideal to bend the expander arms with ease and precision.



PRE-BENT KEYS
FOR EXPANDERS
WITH SAFETY LEASH

Stainless steel. Pre-bent at 45°. Piegate a 45°. For patient.

- A0557-03** 10 keys,
10 safety leashes,
10 instructions for use
-  **A0557-13** 100 keys,
100 safety leashes,
100 instructions for use

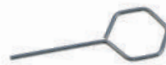

A0557-00
STRAIGHT KEYS FOR
EXPANDERS

Stainless steel.
Only for use in the laboratory.
Pack of 100



P1621-00
INSTRUMENT
FOR ENDORAL ACTIVATION

Suggested for use with multifunctional orthodontic screws.



A0666-01
REAMER

It is used to tap holes into acrylics. Suitable for all expansion screws with 0,4 mm pitch. Refill tip A0669-00.

P1520-00
SCREWDRIVER

For micro spring screws. Tip: 1,5 mm.



MIM® ACTIVATOR TUBE
FOR EXTRAORAL FACEBOW

Manufactured with Metal Injection Moulding technology, it allows high retention into acrylics. Comfortable design. Pack of 10

- A0761-45** ∅ .045"
- A0761-51** ∅ .051"

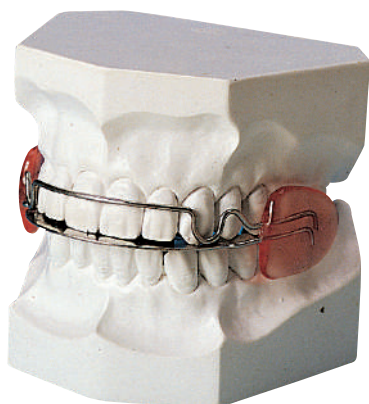

BITE PLANES FOR FUNCTIONAL PLATES

A stainless steel range of products giving the chance of manufacturing high quality functional plates.

Pack of 10



A0720-10
STANDARD
BITE PLANE
Soft, 0,5 mm.



A0596-10
ANATOMICAL DOUBLE
BITE PLANE
Double bite plane in spring hard stainless steel.
Soft, 0,5 mm.



A0721-10
PLATE LATERAL
LEVELS
Soft, 0,5 mm.



A0595-10
ANATOMICAL
BITE PLANE
Soft, 0,5 mm.



A0722-00
DOUBLE
BITE PLANE

DIGITAL WORKFLOW DEVICES

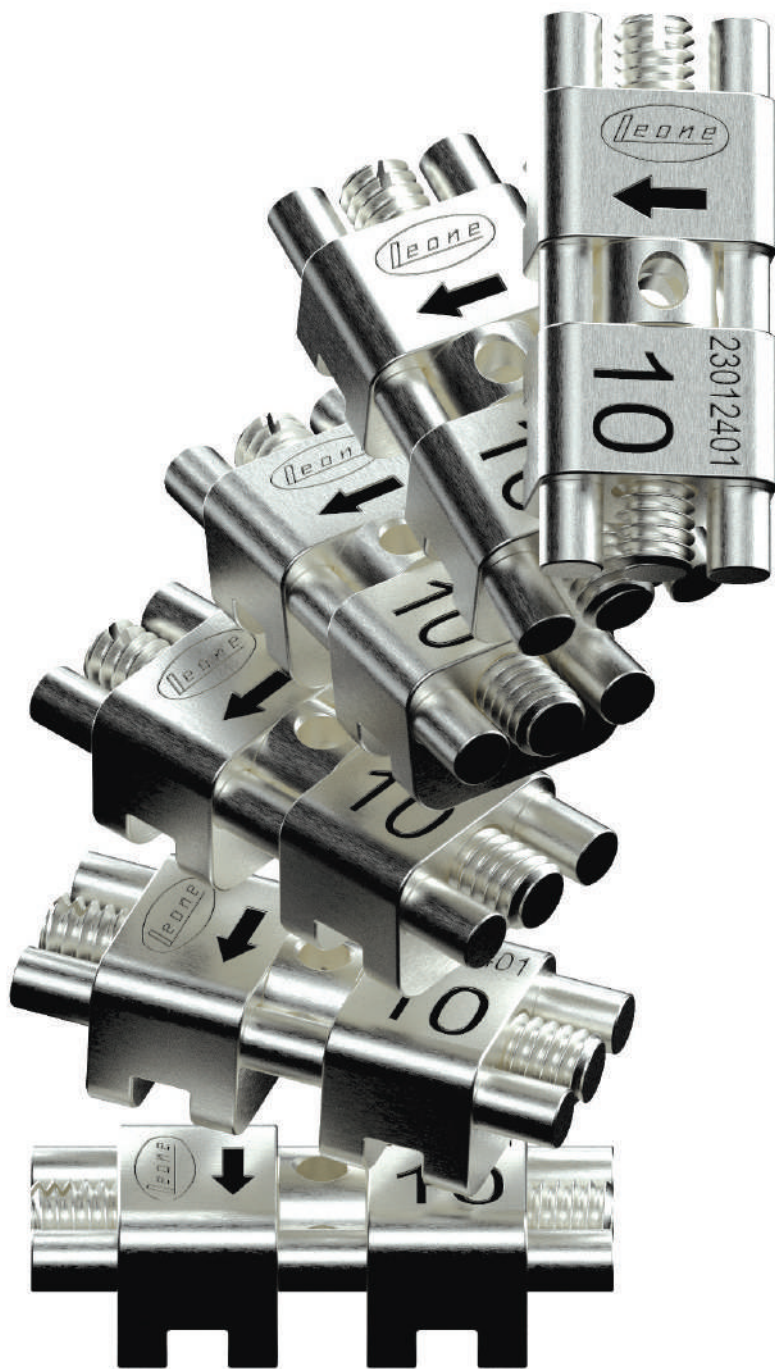

A





PATENTED

**FIRST RPE SCREW
DESIGNED FOR A FULLY
DIGITAL WORKFLOW**

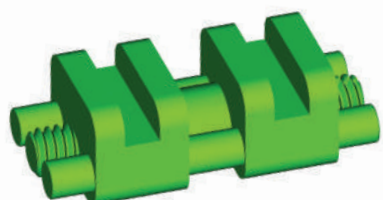

RPE FULLY
DIGITAL DESIGNED

CAD-CAM anatomical expander allows the manufacturing of totally customized appliances with dental anchorage, hybrid (teeth and TADs) and bone borne in a full digital workflow, by using **3DLEONE DESIGNER** software. Thanks to a manufacturing process called Laser Melting, the STL file will become a high precision sintered framework, that will fit perfectly the slot on the expander bodies thus to be joined permanently by laser welding

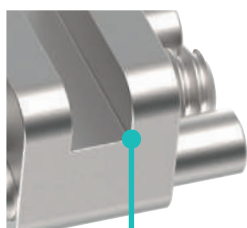

SQUARED SLOTS

The CAD-CAM anatomical expander body feature, instead of the standard arms, squared slots that allow a correct oriented coupling of digitally designed customized laser melted framework and, thanks to their geometric shape, the fully transmission of the expansion forces to the teeth and/or TADs



THE STRONGEST RPE

CAD-CAM anatomical expander is manufactured by biomedical stainless steel with increased mechanical properties and a dedicated geometry of the male screw head that allow us to declare, based on in-vitro tests performed, a strengthness higher than 60kgf, about 50% higher than standard RPE. These features ensure the treatment efficiency even with maxillary expansion in adult patients with 2 or 4 TADs



STRENGTHENED SWIVEL KEY

The strengthened swivel key for CAD-CAM anatomical expander, supplied inside the package, is more resistant than standard one and its use is mandatory in order to enable the full transmission of expansion forces

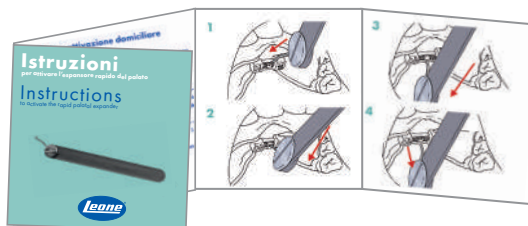

INSTRUCTIONS TO ACTIVATE THE EXPANDER
USEFUL FOR PARENTS AND CLINICIANS

**CAD-CAM ANATOMICAL EXPANDER
OPTIMIZED FOR SKELETAL ANCHORAGE ON TADs**



The CAD-CAM anatomical expander, with a design like the expander with orthogonal arms, is optimized for this particular use: instead of arms, it includes 2 longitudinal square slots in the bodies that allow perfect laser welding with the digitally designed and sintered structure. The small size of the body, the unique self-centring guide system, and the use of biomedical steel with superior resistance for guides and male screw, allow optimal positioning of the expander even in cases of severe contraction, favouring biomechanical control of expansion even in MARPE therapies on adult patients. It is possible to digitally design hybrid expanders, with both dental and skeletal anchorage, or entirely skeletal anchorage on TADs. The expansion capacity, expressed in mm, the arrow indicating the activation direction, and the lot number are laser-marked on the body.

Package includes:

- 1 stainless steel key
- 1 hinged enhanced-key with handle
- Instructions for the patient for at-home endoral activation

Packs of 1



.Stl file available on the website www.leone.it and included in the library of 3DLEONE DESIGNER software

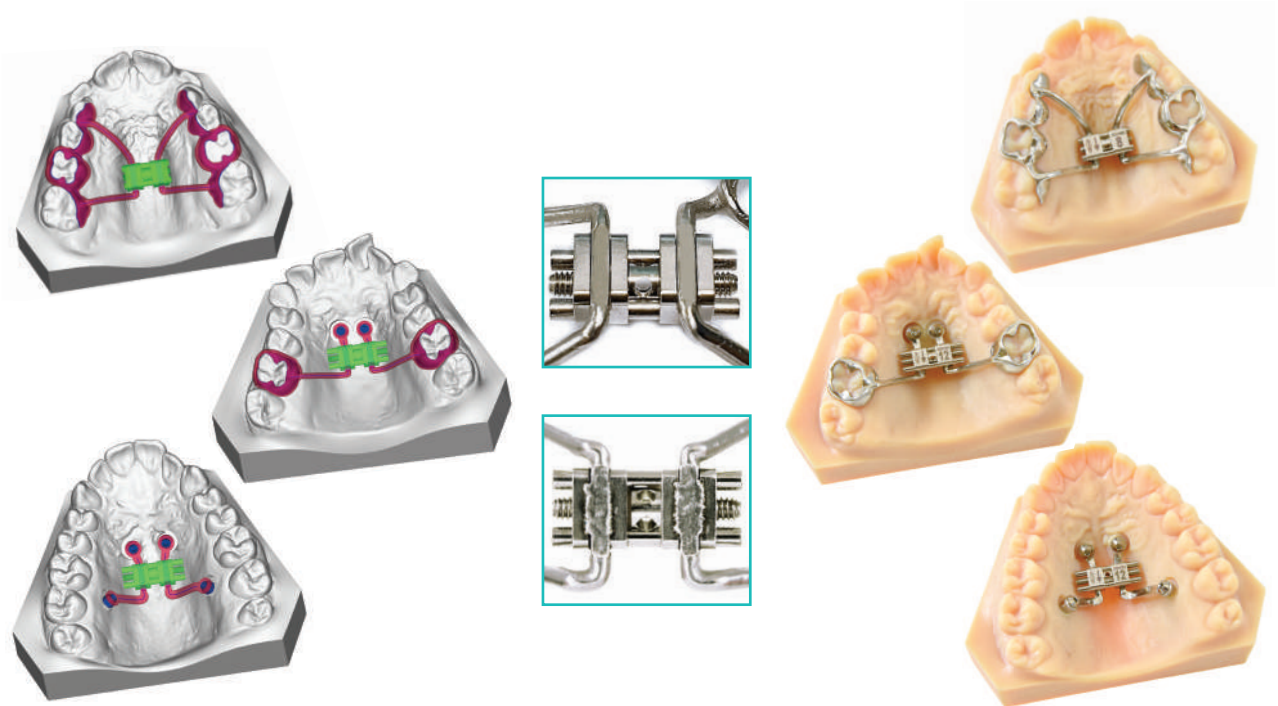

6 mm front view	4,5 mm back view		body			activation turns for maximum expansion limit	
		A0630-08D	1,5x1,5mm	12 mm	8 mm	0,8 mm	40
		A0630-10D	1,5x1,5mm	14 mm	10 mm	0,8 mm	50
		A0630-12D	1,5x1,5mm	16 mm	12 mm	0,8 mm	60



PATENTED

**NEW EXPANDERS
DESIGNED FOR TOOTH BORNE
APPLIANCES**



Leone's CAD-CAM Tooth Borne expander series broadens the Leone expander CAD-CAM range. The most popular and used Leone expanders has been optimized to be included in a fully digital workflow to manufacture expansion appliances with dental anchorage. The CAD-CAM Tooth Borne expanders are made of stainless steel and manufactured according to the high-quality Leone standards. They feature transversal housings to be coupled with the digital designed and sintered framework, instead of the arms as the classic models.

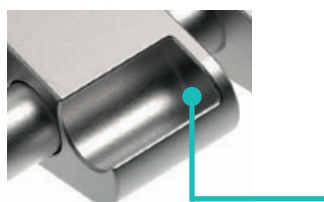

EMBEDDED SLOTS

The Tooth Borne CAD-CAM expanders bodies feature slots embedded in the body profile that allow a correct oriented coupling of digitally designed customized laser melted framework. This feature guarantees a high reliability of the device throughout the therapy.

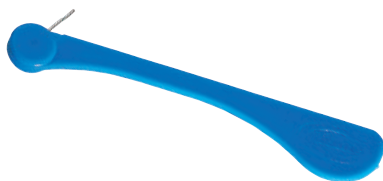

SWIVEL KEY

Each expander comes with the classic blue swivel key. Also available with activation turn counter

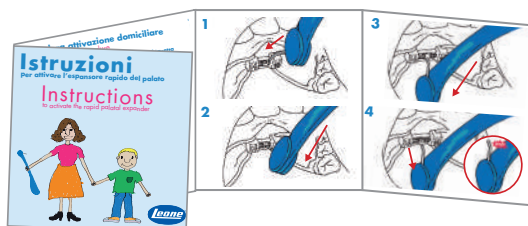

INSTRUCTIONS FOR USE OF EXPANDERS
USEFUL FOR PARENTS AND CLINICIANS

NEW

**RAPID EXPANDER
TOOTH BORNE**



The CAD-CAM Rapid Expander Tooth Borne screw is the optimized CAD-CAM version of the Leone's best seller expander: instead of the arms, it has four transversal housings with an ending stop on the bodies that allow a perfect oriented coupling with the digitally designed and SLM manufactured framework, thus assuring an optimal laser welding process. It is recommended for the utilization on tooth borne appliances. This series of expanders keeps all the features and sizes of our worldwide famous expander, allowing doctors to smoothly switch to digital manufactured RPEs. Expansion capacity in mm, directional arrow and lot number are laser marked on the body of the screw.

Supplied with:

- 1 stainless steel key (to be used only inside the lab)
- 1 blue swivel key with handle
- Instructions for the patient for at-home endoral activation

Pack of 1

.Stl file available on the website www.leone.it and included in the library of **3DLEONE DESIGNER** software

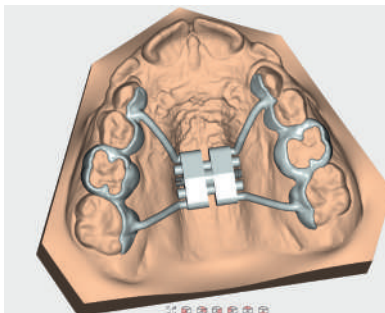
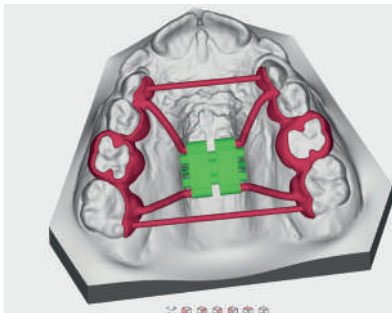

11 mm front view	4 mm back view		body			activation turns for maximum expansion limit	
		A0620D08	2 mm	12 mm	8 mm	0,8 mm	35
		A0620D09	2 mm	14 mm	9 mm	0,8 mm	40
		A0620D11	2 mm	16 mm	11 mm	0,8 mm	50
		A0620D13	2 mm	18 mm	13 mm	0,8 mm	60

NEW

**EASY ACCESS MICRO EXPANDER
TOOTH BORNE**



This expander is the optimized CAD-CAM version of the Stealth Easy Access. Instead of the arms, it has two transversal housings with an ending stop on the bodies that allow a perfect oriented coupling with the digitally designed and SLM manufactured framework, thus assuring an optimal laser welding process.

Thanks to the more visible screw holed-head, the micro expander A1621D allows an easier intraoral activation with the swivel key. It is recommended for dental anchored expanders. This series of expander keeps all the features and sizes of our classic worldwide famous expander, allowing doctors to smoothly switch to digital manufactured RPEs. Expansion capacity in mm, directional arrow and lot number are laser marked on the body of the screw.









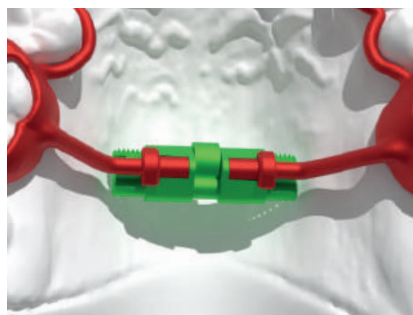
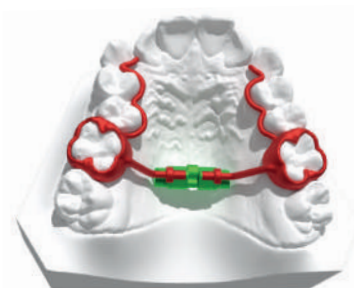



Supplied with:

- 1 stainless steel key (to be used only inside the lab)
- 1 swivel key with handle
- Instructions for the patient for at-home endoral activation

Pack of 1

.Stl file available on the website www.leone.it and included in the library of **3DLEONE DESIGNER** software



 4,95 mm front view	 4,05 mm back view		 body			activation turns for maximum expansion limit	
		A1621-08D	2 mm	12 mm	8 mm	0,8 mm	35
		A1621-11D	2 mm	16 mm	11 mm	0,8 mm	50
		A1621-13D	2 mm	18 mm	13 mm	0,8 mm	60

NEW

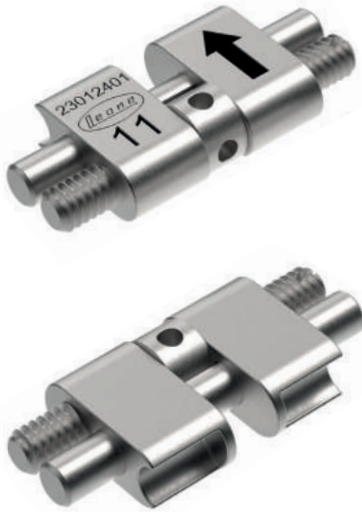

**EXPANDER LOWER ARCH
TOOTH BORNE**

The CAD-CAM expander for lower arch Tooth Borne is the optimized CAD-CAM version of the Torco lower screw. Instead of the arms, it has two transversal housings with an ending stop on the bodies that allow a perfect oriented coupling with the digitally designed and SLM manufactured framework, thus assuring an optimal laser welding process. The main characteristics are the same of the classic A0623 expanders, featuring a flat profile that reduces the overall bulkiness, particularly important since it is recommended for the use on lower jaw tooth borne appliances. Expansion capacity in mm, directional arrow and lot number are laser marked on the body of the screw.









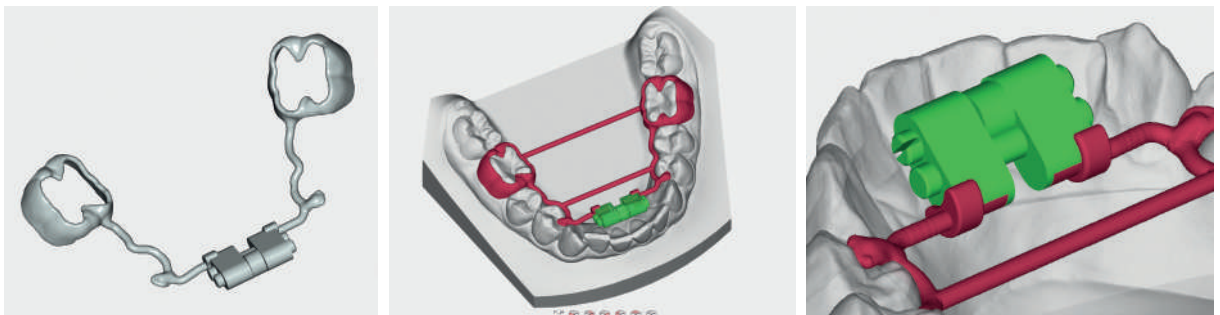

Supplied with:

- 1 stainless steel key (to be used only inside the lab)
- 1 key with safety ring leash
- Instructions for the patient for at-home endoral activation

Pack of 1

.Stl file available on the website www.leone.it and included in the library of **3DLEONE DESIGNER** software



						activation turns for maximum expansion limit	
7,5 mm front view	4 mm back view		body				
		A0623-08D	2 mm	12 mm	8 mm	0,8 mm	35
		A0623-11D	2 mm	16 mm	11 mm	0,8 mm	50

NEW

**LEAF EXPANDER
TOOTH BORNE**

The CAD-CAM Leaf Expander is a spring loaded expander that, along with the male screw, has two or three MEMORIA Ni-Ti leaf springs that allow the release of calibrated and continuous forces to promote the expansion of the maxillary arch. It is a device optimized for the CAD-CAM procedure, instead of the arms it has four transversal rounded slots on the bodies that allow a correct oriented coupling for the welding of digitally designed customized laser melted framework. The main features are the same as the standard Leaf expander series. It is recommended for the utilization on tooth borne appliances. This expander series keeps the efficiency of the classic expander while looking towards the future.

- Supplied with:
- 1 stainless steel key (to be used only inside the lab)
 - 1 swivel key with handle
- Pack of 1**

.Stl file available on the website www.leone.it and included in the library of **3DLEONE DESIGNER** software

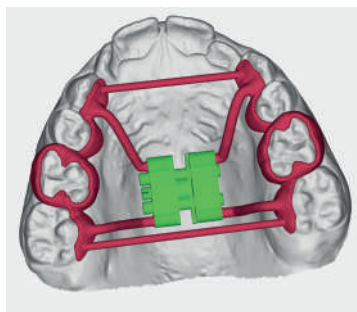

11 mm front view	4 mm back view		body			activation turns for maximum expansion limit	
		A2703-06D 2 springs 450 g approx.	2 mm	12 mm	6 mm	0,4 mm	30
		A2704-06D 2 springs 900 g approx.					
		A2703-09D 3 springs 450 g approx.	2 mm	16 mm	9 mm	0,4 mm	45
		A2704-09D 3 springs 900 g approx.					

EXPANDER ACTIVATION GUIDELINES		LEAF EXPANDER cementation		FIRST visit	SECOND visit	THIRD visit	
6 mm	A2703-06D A2704-06D	spring activation 0 turns	after 6 weeks	10 turns	after 4 weeks	10 turns	after 4 weeks 10 turns
9 mm	A2703-09D A2704-09D	spring activation 0 turns	after 8 weeks	15 turns	after 6 weeks	15 turns	after 6 weeks 15 turns

NEW







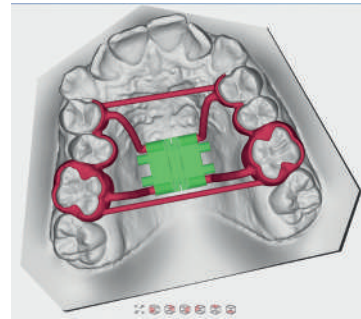
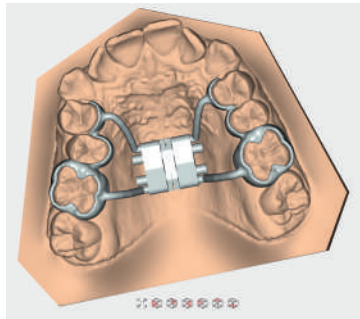

**LEAF SELF EXPANDER
TOOTH BORNE**

Leaf Self Expander is a spring loaded expander equipped with four or six MEMORIA Ni-Ti leaf springs that allow the release of calibrated and continuous forces to promote the expansion of the maxillary arch. It is a device optimized for the CAD-CAM procedure; instead of the arms it has four transversal rounded slots on the bodies that allow a correct oriented coupling for the welding of digitally designed customized laser melted framework. The main features are the same as the standard Leaf expander series. It is recommended for the utilization on tooth borne appliances. This expander series keeps the efficiency of the classic expander while looking towards the future.

Pack of 1

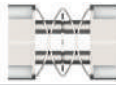
.Stl file available on the website www.leone.it and included in the library of 3DLEONE DESIGNER software

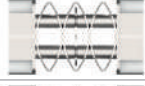
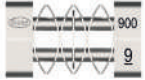
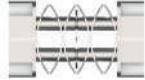

 11 mm front view		 4 mm back view		 body			
 450 6		A2705-06D	4 springs 450 g approx.	2 mm	11 mm	6 mm	
 900 6		A2706-06D	4 springs 900 g approx.				
 450 9		A2705-09D	6 springs 450 g approx.	2 mm	15 mm	9 mm	
 900 9		A2706-09D	6 springs 900 g approx.				



MODELS
ORIENTATION

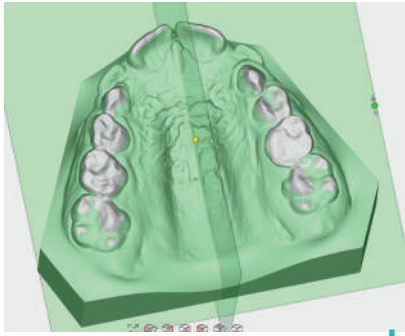

SCREW POSITION
DEFINITION

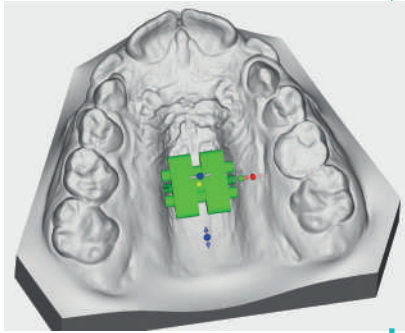

BANDS
DEFINITION

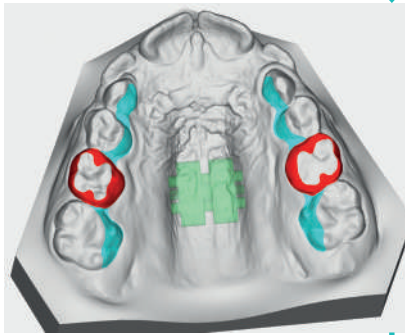

ARMS
DEFINITION

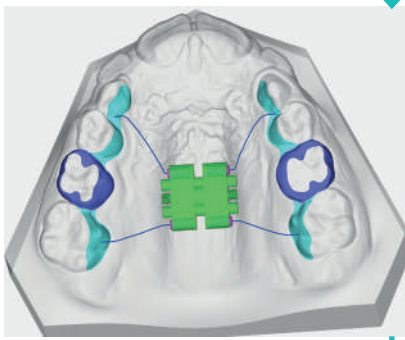

SUPPORT
DEFINITION

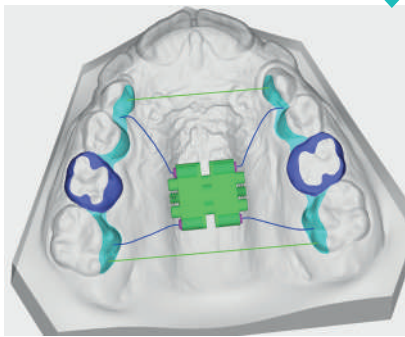

**3DLEONE DESIGNER
SOFTWARE**

3DLEONE DESIGNER is the first software based on an easy and driven workflow for the digital design of customized framework to be coupled with our innovative CAD-CAM expanders.

Based on our experience with many different software in the dental field and due to the increased customer requests, Leone has made out an innovative and intuitive software that allows to design, not only bands and supports, but also the expander arms, and can automatically place the expander also in the right position, in very short time and independently from the digital skills.

3DLEONE DESIGNER software allows to upload and manage the .STL files of both upper and lower arches, obtained from a laboratory scanner or directly from an intra-oral scanner, and it has already in library all the range of Leone's CAD-CAM expanders available.

Once the digital driven workflow is completed, thanks to an innovative technology called Selective Laser Melting, the designed .STL file will become, a high precision sintered framework and will be coupled perfectly with the chosen Leone CAD-CAM expander. Then the framework and the expander will be permanently laser welded.

FOR FURTHER INFORMATION
ON **3DLEONE DESIGNER**
SOFTWARE VISIT WEB SITE **3DLEONE.IT**



REVIEW &
EXPORT

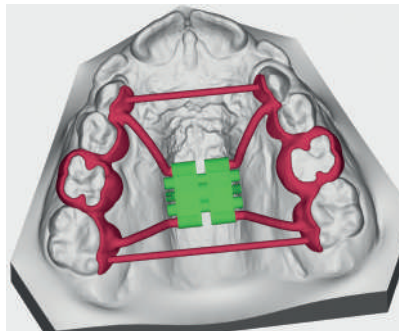

ANTISNORING APPLIANCES



A



M.A.D.
SERIES LEONE

These intraoral nighttime appliances can treat snoring by acting directly on the mechanism which is the main cause of it, by pushing the lower jaw forward. Mandibular repositioning pushes forward the tongue and the epiglottis, spacing them from the uvula, thus solving the soft tissues vibration during the airflow, which creates the snoring sound. MAD appliances can be used for the treatment of sleep apnea (OSA) since they can solve the rear airways obstruction by restoring breathing capacity during sleeping time. The American Academy of Dental Sleep Medicine claims that the most efficient appliances are bi-maxillary type, custom-made by a dental lab and, furthermore, they must allow an additional advancement over the construction bite position, about 4-5 mm. All over the world there are many different types of MAD appliances to treat snoring syndrome and sleep apnea. We have decided to accomplish and improve the elements for the realization of the most widely used appliances according with clinical and scientific proven efficiency. This is our proposal based on the requirements of any clinical specialist: **appliance efficiency, high safety standards, and stability and comfort for the patient.**

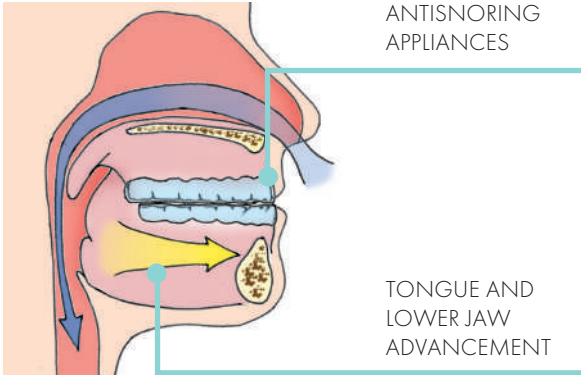

ANTISNORING BIMAXILLARY DORSAL TYPE APPLIANCES

FORWARD!*



FORWARD!
MAX RETENTION*

TELESCOPIC ADVANCER PLUGS AND TUBE APPLIANCES

TELESCOPIC ADVANCER*



TELESCOPIC ADVANCER DUAL*

*PATENTED



FORWARD!
ANTISNORING KIT

A5300-07
1 appliance

A5300-17
10 appliances

The first hardware kit specifically engineered for the antisnoring bi-maxillary Dorsal type appliance. This time-saving kit includes all the necessary components for an easier and more precise construction of the appliance. The kit for the assembly of 1 appliance is made up of:
- 2 upper screws, 1 right and 1 left
- 2 lower wings with inner steel frame, 1 right and 1 left.
A kit for the construction of 10 appliances is available.

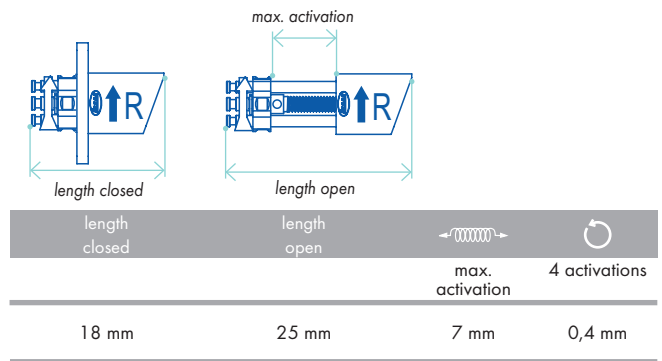

REFILLS FOR FORWARD!

A5301-00
Lower wings
with inner steel frame



Pack content:
- 1 left lower wing with steel frame
- 1 right lower wing with steel frame

A5302-00
Screw 70° angulated body



Pack content:
- 1 upper right screw
- 1 upper left screw



FORWARD! MAX RETENTION ANTISNORING KIT

A5310-07
1 appliance

A5310-17
10 appliances

This kit is specially engineered for the realization of an antisnoring bi-maxillary Dorsal type appliance and this version is featured by a higher retention capacity of the upper screws in the acrylic splint, thanks to the distal "U" bent guide.

It contains all the necessary components for a fast and precise construction of the appliance.

The kit for the construction of 1 appliance is made up of:

- 2 upper screws with "U" guide, 1 right and 1 left
 - 2 lower wings with inner steel frame, 1 right and 1 left.
- A kit for the construction of 10 appliances is available.

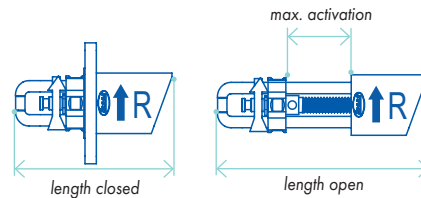

length closed	length open	max. activation	4 activations
20 mm	27 mm	7 mm	0,4 mm

REFILLS FOR FORWARD! MAX RETENTION

A5301-00

Lower wings with inner steel frame



Pack content:

- 1 left lower wing with steel frame
- 1 right lower wing with steel frame

A5312-00

Max Retention 70° angulated screw and "U" bent guide



Pack content:

- 1 upper right screw
- 1 upper left screw

FORWARD! AND FORWARD! MAX RETENTION FEATURES



The upper screws are specifically designed to get a thrust on the inclined plane of the lower unit: the protrusive anterior portion is a **metallic body perfectly angulated at 70°**, while the posterior portion has extensive retention capacity for the acrylic to avoid breakages. The screw mechanism has a **built-in stop** that gives both **perfect friction** and stability during the forward movement, as well as preventing the screw from coming apart once **7 mm** of maximum elongation is reached.



Each upper screw has an arrow clearly laser marked on metal front body, indicating the **direction of activation** to get the forward movement. The screws, both left and right, are specifically manufactured to get a **single direction of activation** on both sides and minimize mistakes. Each directional activation generates 0.1 mm advancement.



The lower wings, one right and one left, are **anatomically shaped for superior comfort** and perfect matching with the 70° inclined plane of the upper screw bodies. The clear material is fully compatible with any orthodontic acrylic resin, while the inner metallic **frame can be anatomically adapted** and incorporated into the resin of the lower splint, to ensure superior strength for the mandibular advancement in adult patients.



TELESCOPIC ADVANCER ANTISNORING KIT

A5100-07
1 MEDIUM appliance

A5100-17
10 MEDIUM appliances

A5200-07
1 LONG appliance

A5200-17
10 LONG appliances



The kit, specifically engineered for the construction of one anti-snoring appliance with telescopic plugs and tubes, includes all the components for an easier and precise construction of the appliance.

- 1 kit for the assembly of 1 appliance is made up of:
- 2 Telescopic arms (plug and tube), 1 right and 1 left
 - 4 housings for acrylic
 - 4 housing screws
 - 1 wrench for activation

A multiple kit for the assembly of 10 appliances is also available.

	length closed	length open	stroke max.	max. activation	4 activations
<p>MEDIUM Telescopic arm</p>	26 mm	43 mm	10 mm	7 mm	0,4 mm
<p>LONG Telescopic arm</p>	31 mm	53 mm	15 mm	7 mm	0,4 mm

REFILLS FOR TELESCOPIC ADVANCER

A5101-00
Housing screws and wrench for activation



Pack content:
- 4 housing screws
- 1 wrench for activation

A5101-01
Housings with screws and wrench for activation



Pack content:
- 4 housings for acrylic
- 4 housing screws
- 1 wrench for activation

A5101-02
MEDIUM Telescopic Arms



Pack content:
- 1 Telescopic Arm MEDIUM right
- 1 Telescopic Arm MEDIUM left

A5201-00
LONG Telescopic Arms



Pack content:
- 1 Telescopic Arm LONG right
- 1 Telescopic Arm LONG left



P1515-00 FAN-TYPE HAND WRENCH

Thanks to its design, this screwdriver allows to easily tighten the fixing screws for support of the Telescopic Advancer devices.



The plug and tube components are manufactured by using **biocompatible stainless steel with the highest strength** available providing durability to any biomechanical stress. The plug component features a special design that does not permit the disassembling from the tube even when the patient is in wide-open mouth position.

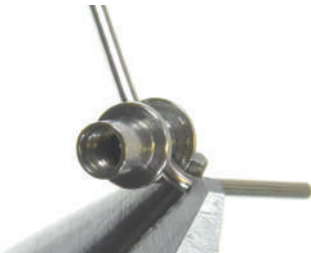

The housings for acrylic are designed to be embedded in the acrylic splint: they feature a **laser welded wire throughout** that can be easily bent to enhance the resin retention and avoid unwanted detachment. The outer part presents a threaded portion to accommodate the square head screws binding the ends of the Telescopic arms.

The **wrench for activation** supplied with the kit can be used in the laboratory to tighten the square head screws.



The same instrument is necessary to activate the square head advancer screw into the plug in the direction indicated by the laser etched arrow: each quarter turn of activation produces 0.1 mm advancement.

The maximum elongation is 7 mm on both sides.



A ruler is laser etched on the wrench handle to check the activation length throughout treatment.



TELESCOPIC ADVANCER DUAL ANTISNORING KIT



A5120-07
1 MEDIUM appliance

A5120-17
10 MEDIUM appliances

A5220-07
1 LONG appliance

A5220-17
10 LONG appliances

This kit is specially engineered for the construction of an antisnoring appliance with telescopic plugs and tubes and this version is featured by a dual possibility of activation. It can be activated either by acting on the square head portion of the inner advancer screw, or by using the pin of the wrench in the holes close to the square head portion. The two types of activation can be performed thanks to the dedicated extremities of the DUAL activation wrench, supplied with the device. The diameter of the advancer screw has been increased and its resistance is 25% higher than the standard model. The arms are specifically manufactured to have a single direction of activation on both the right and the left side, from the bottom to the top, to minimize the home activation mistakes and eventual

asymmetries of the appliance. The advancer screw has alternatively laser-marked bands that allow to measure the millimeters of protrusion. All the components are made up of high resistance biomedical stainless steel that ensures a high reliability to all biomechanical stresses. The peculiar shape of the telescopic plug and tube keeps connected the upper and the lower splints even when the patient's mouth is widely open. The kit, that is different from the Telescopic Advancer standard only for the Telescopic arms Dual, contains all the necessary components for a fast and precise construction of the appliance and it is made up of:

- 2 telescopic arms Dual (plug and tube), 1 right and 1 left
- 4 housings for acrylic
- 4 housing screws
- 1 Dual wrench for activation

A multiple kit for the construction of 10 appliances is available

	length close	length open	stroke max.	max. activation	4 activations
<p>Telescopic Arm Dual MEDIUM</p>	26 mm	43 mm	10 mm	7 mm	0,4 mm
<p>Telescopic Arm Dual LONG</p>	31 mm	53 mm	15 mm	7 mm	0,4 mm

REFILLS FOR DUAL TELESCOPIC ADVANCER

A5121-00
Housing screws and Dual wrench for activation



Pack content:
- 4 housing screws
- 1 Dual wrench for activation

A5121-01
Housings with screws and Dual wrench for activation



Pack content:
- 4 housings for acrylic
- 4 housing screws
- 1 Dual wrench for activation

A5121-02
Telescopic Arm Dual MEDIUM



Pack content:
- 1 Telescopic Arm Dual MEDIUM right
- 1 Telescopic Arm Dual MEDIUM left

A5221-00
Telescopic Arm Dual LONG



Pack content:
- 1 Telescopic Arm Dual LONG right
- 1 Telescopic Arm Dual LONG left



The Dual activation wrench can be used to activate the Telescopic arm by acting on both, the square head of the advancer screw and the hole close to the square head.

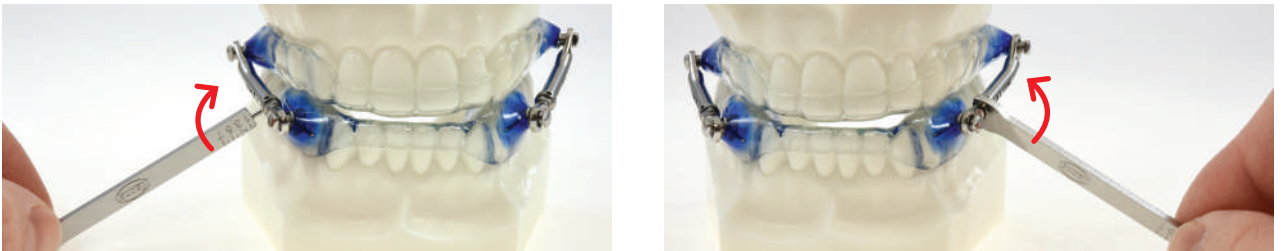

The direction of activation is laser marked on the Telescopic arm and it is the same for the Telescopic left and right arms (bottom to top). Each quarter turn of activation produces 0.1 mm advancement: the maximum elongation is 7 mm on each side.



The inner advancer screw has laser marked bands that, alternating with unmarked thread portions, allow to measure the amount of protrusion. Another element that allows a better perception of activation is the black arrow alternatively laser marked on the square nut.



In addition, a ruler is laser marked on the handle of the Dual wrench for activation, that allows to verify the millimeters of activation carried out during treatment.



PLATE HOLDERS

Manufactured from non toxic, unbreakable plastic. With inner socket for key and one space for patient's phone number.

A3038-99 Small
A3039-99 Large

PLATE HOLDER KIT ASSORTED COLORS

Pack of 200:
 - 30 white
 - 30 pink
 - 40 yellow
 - 40 blue
 - 30 green
 - 30 orange



SMALL	LARGE	pkg.	colour	SMALL	LARGE	pkg.
A3038-00	A3039-00		white	A3038-93	A3039-93	
A3038-00S	A3039-00S		pink	A3038-93S	A3039-93S	
A3038-00G	A3039-00G		yellow	A3038-93G	A3039-93G	
A3038-00A	A3039-00A	10	blue	A3038-93A	A3039-93A	200
	A3039-00F		fluorescent		A3039-93F	
A3038-00V	A3039-00V		green	A3038-93V	A3039-93V	
A3038-00E	A3039-00E		orange	A3038-93E	A3039-93E	