

B

**DIAGNOSTIC
DIAGNOSTICA**

MOUTH MIRRORS BY DR. COMELLA

SPECCHIETTO DEL DR. COMELLA



DROP SHAPE MIRROR

The mirror is an indispensable tool for inspecting the oral cavity, soft tissues, anterior and posterior teeth and for all kind of conservative treatment. An improvement to these standard procedures has been achieved with the introduction of our new "drop shape" mirror which facilitates the control of the soft tissues, better protects the tongue wall and above all it offers a larger view of the superior molar portion and of the oral cavity in general. Furthermore the elongated "drop shape" guarantees a wider reflection surface and therefore a major visibility of the oral cavity.

(Protected by international patent)

SPECCHIETTO A GOCCIA

Lo specchietto odontoiatrico rappresenta lo strumento necessario per l'ispezione del cavo orale, dei tessuti molli, denti anteriori e posteriori e come protezione nelle manovre conservative. Una miglioria per tutte queste attività è ottenuta con l'introduzione del nuovo specchietto "a goccia" il quale agevola il controllo dei tessuti molli, protegge la lingua e offre una più ampia retrospettiva del versante vestibolare. In aggiunta, il nuovo specchietto "a goccia" garantisce una maggior luce riflessa aumentando così la luminosità del cavo orale.

(Protetto da brevetto internazionale)

4903/10RO
Rhodium – Box 6 pcs
Rodio – Scatola 6 pezzi



4903/10RO.NE
Rhodium – Nerissimo – Box 6 pcs
Rodio – Nerissimo – Scatola 6 pezzi

NEWS



MOUTH MIRRORS

SPECCHIETTI

MOUTH MIRRORS IN BOX OF 12 PCS
SPECCHIETTI IN CONFEZIONI DA 12 PZ

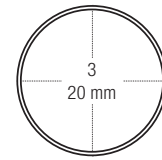

4903/3
Plane N. 3
Piano N. 3

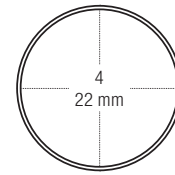

4903/4
Plane N. 4
Piano N. 4

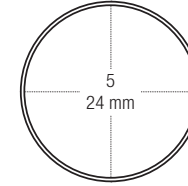

4903/5
Plane N. 5
Piano N. 5

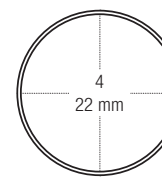

4903/4RO
Rhodium N. 4
Al Rodio N. 4

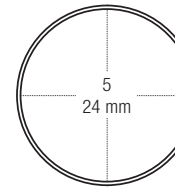

4903/5RO
Rhodium N. 5
Al Rodio N. 5

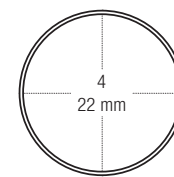

4903/4MA
Magnifying N. 4
Concavo ingrandente N. 4

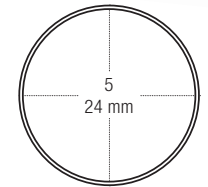

4903/5MA
Magnifying N. 5
Concavo ingrandente N. 5

DOUBLE SIDE MIRRORS IN BOX OF 6 PCS
SPECCHIETTI DOPPII IN CONFEZIONI DA 6 PZ



4912/4RO
Double sided – Rhodium N. 4
Doppio – Rodio N. 4



4912/5RO
Double sided – Rhodium N. 5
Doppio – Rodio N. 5



4912/4RO.NE
Double sided – Rhodium N. 4
Nerissimo
Doppio – Rodio N. 4
Nerissimo



4912/5RO.NE
Double sided – Rhodium N. 5
Nerissimo
Doppio – Rodio N. 5
Nerissimo

MOUTH MIRRORS HANDLES MANICI PER SPECCHIETTI



4905/6
ø mm 6
mm 120

4905/8MV
Anatomic
ø mm 8
mm 125

4905/8 (mm 120)
4905/8.NE (mm 120)
Hollow handle
Manico vuoto
ø mm 8

4905/10
Hollow handle
Manico vuoto
ø mm 10
mm 120

4900
Octagonal handle
Manico ottagonale
mm 120

4902
Hollow handle
Manico vuoto
mm 125

4904
Hollow handle
Manico vuoto
mm 130

AVAILABLE CONE-SOCKET



4906/GR
Aluminium green
Alluminio verde
mm 120

4906/SI
Aluminium silver
Alluminio argento
mm 120

4906/RE
Aluminium red
Alluminio rosso
mm 120

4906/YE
Aluminium yellow
Alluminio giallo
mm 120

4906/BL
Aluminium blue
Alluminio blu
mm 120

“ MEDESYS IN SPOT

ATTENTION: handles made in anodized aluminium: for a correct maintenance do not use products that are too alkaline or acid as they may discolor the surface. More info on www.medesy.it

ATTENZIONE: manici in alluminio anodizzati, non utilizzare prodotti troppo alcalini o acidi in quanto possono decolorare la superficie. Maggiori informazioni su www.medesy.it ”



COTTON AND DRESSING TWEEZERS PINZETTE PER MEDICAZIONI



1022
Perry
mm 130

1023
Flagg
mm 150

1024
Meriam
mm 160

1026
College
mm 150

1124/D
Meriam
Diamond coated
Diamantata
mm 160

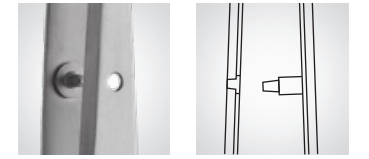

Prevents side-slipping of tips
Evita l'accavallarsi delle punte



1122
Perry
mm 130

1123
Flagg
mm 150

1124
Meriam
mm 160

1126
College
mm 150

1126/L
College
Smooth
Liscia
mm 150

1120
College
Light pattern
Modello leggero
mm 150

1118
College
With lock
Con fermo
mm 150



555/2.SL
Explorer N. 2
Specillo N. 2



555/23.SL
Explorer N. 23
Specillo N. 23



555/6.SL
Explorer N. 6
Specillo N. 6



555/8A.SL
Explorer N. 8A
Specillo N. 8A



555/9.SL
Explorer N. 9
Specillo N. 9



560/1.SL
Explorer N. 23-17
Specillo N. 23-17



560/2.SL
Explorer N. 23-17A
Specillo N. 23-17A



560/3.SL
Explorer N. 23-6
Specillo N. 23-6



4907/AR
Mirror handle
Manico specchietto



4907/RO
Mirror handle
Manico specchietto



4907/VE
Mirror handle
Manico specchietto

EXPLORERS SPECILLI

555/2
555/2.HL8
555/2.SL

555/23
555/23.HL8
555/23.SL
555/23.NE

555/54
555/54.HL8

555/16
555/16.HL8

555/11
555/11.HL8

555/6
555/6.HL8
555/6.SL
555/6.NE

555/8
555/8.HL8

555/8A
555/8A.HL8
555/8A.SL
555/8A.NE

555/10
555/10.HL8

555/12
555/12.HL8

555/9
555/9.HL8
555/9.SL
555/9.NE

555/3
555/3.HL8

555/3A
555/3A.HL8

555/5
555/5.HL8

555/17
555/17.HL8

555/17A
555/17A.HL8

(1:1 scale / scala 1:1)

NEWS

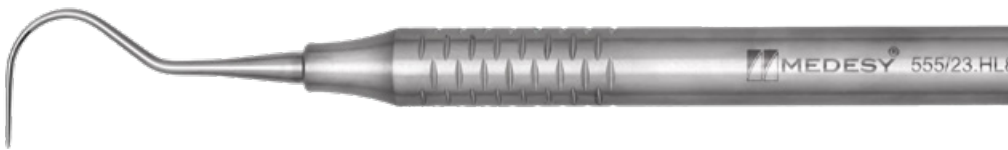

“ MEDESYS IN SPOT

Explorers now available also with the brand new Dalila 8 mm handle, try and feel the best comfort also in the diagnostic phase!

Specilli ora disponibili anche nel nuovo manico Dalila 8 mm, prova un comfort maggiore anche in fase diagnostica! ”

EXPLORERS EXTRA THIN SPECILLI EXTRA FINI

556/2
Extra thin
Extra fino

556/23
Extra thin
Extra fino

556/9
Extra thin
Extra fino

556/6
Extra thin
Extra fino

556/8A
Extra thin
Extra fino

Brand new micro-explorers, thinner and more flexible than standard explorers for an extremely delicate touch and precise control of the instrument.

Nuovi micro-specilli, più sottili e flessibili rispetto lo specchio tradizionale per elevare il grado di sensibilità in fase di esplorazione.

1670/1

Diagnostic kit
Kit diagnostico

Content / Contenuto:	
1024	Tweezer Meriam
4905/8	Mirror handle with mirror # 5
548/4	Probe CP15
560/2	Explorer double 23/17
978	Gammafix tray UN

Content can be changed upon request
Su richiesta il contenuto può essere cambiato

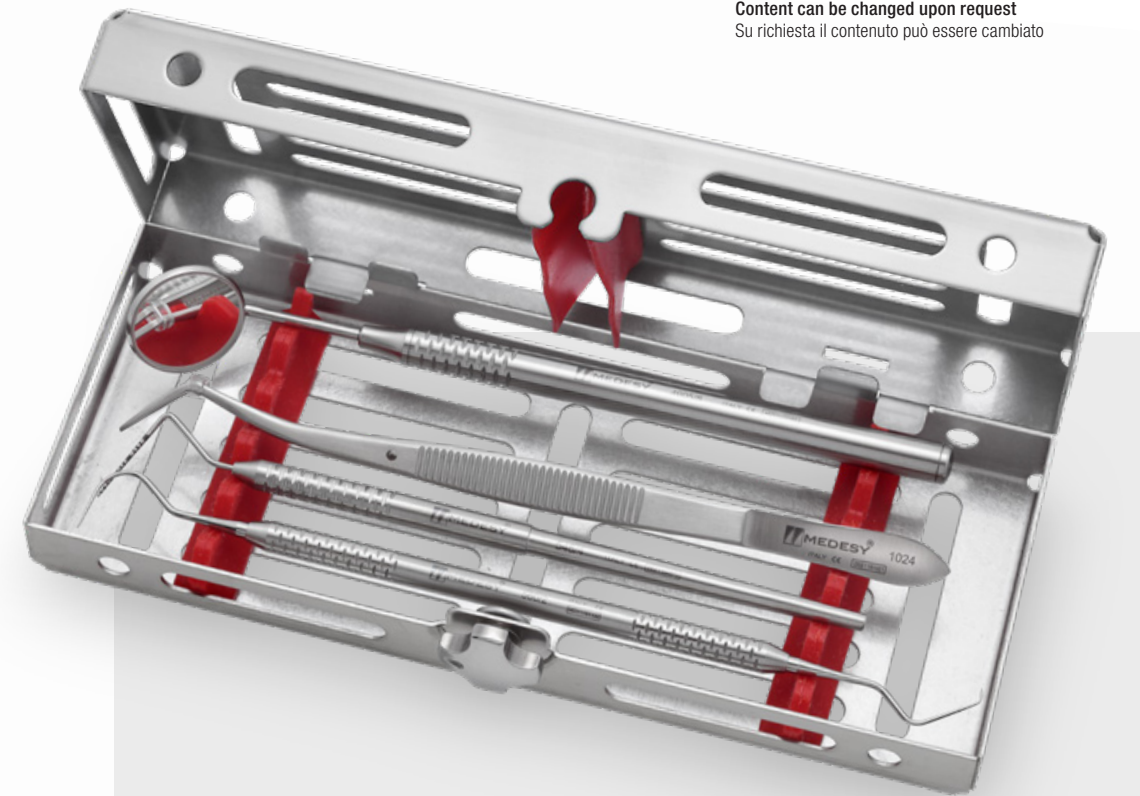

EXPLORERS DOUBLE-ENDED SPECILLI DOPPI

560/1
(1:1 scale / scala 1:1)



560/1
560/1.HL8
560/1.SL
Explorer N. 23-17
Specillo N. 23-17

560/2
560/2.HL8
560/2.SL
Explorer N. 23-17A
Specillo N. 23-17A

560/3
560/3.HL8
560/3.SL
Explorer N. 23-6
Specillo N. 23-6



560/4
560/4.HL8
Explorer N. 6-3
Specillo N. 6-3

560/5-6
560/5-6.HL8
Explorer N. 5-6
Specillo N. 5-6

560/17-3A
560/17-3A.HL8
Explorer N. 17-3A
Specillo N. 17-3A

CNC Dept., for the manufacturing of Medesy's handle and tips.
Reparto torni automatici CNC, per la produzione dei manici Medesy e relative punte.



556/11-12
Extra thin N. 11-12
Extra fino N. 11-12

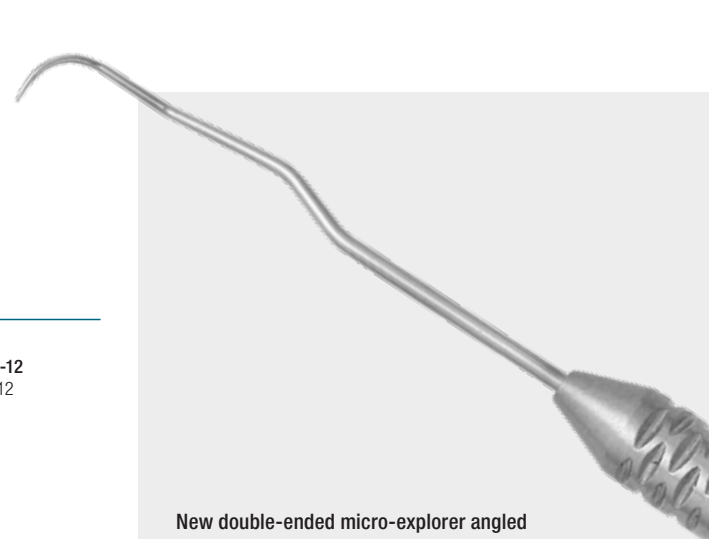

New double-ended micro-explorer angled as Gracey 11-12, ideal for periodontal assessment and detection of subgingival calculus in deep pockets.

Nuovo micro-specillo doppio con pieghe stile Gracey 11-12, ideale per diagnosi parodontale in calcoli subgingivali e tasche profonde.

PERIODONTAL PROBES DOUBLE-ENDED SONDE PARODONTALI DOPPIE

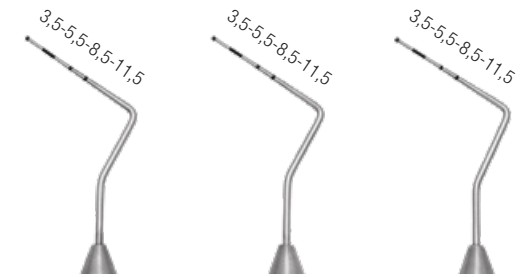

563/1
Who CP15

563/2
Who CP12

563/3
Who Williams

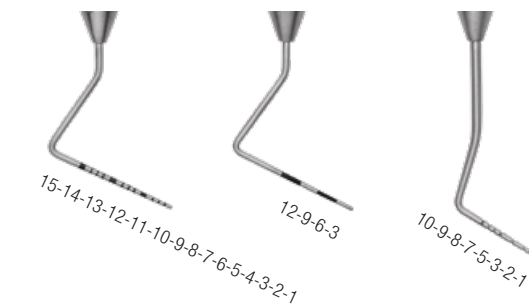

568/1
Williams Goldman-Fox

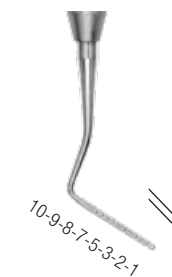

FURCATION PROBES SONDE PER FORCAZIONI



569/2
Nabers 2N

569/2 COL
Nabers 2N
Color coded

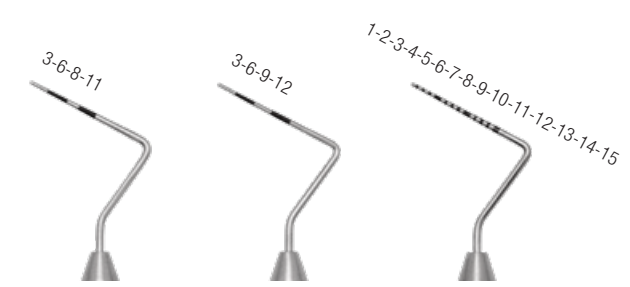

570/1
CP11
Explorer N. 23

570/2
CP12
Explorer N. 23

570/3
CP15
Explorer N. 23

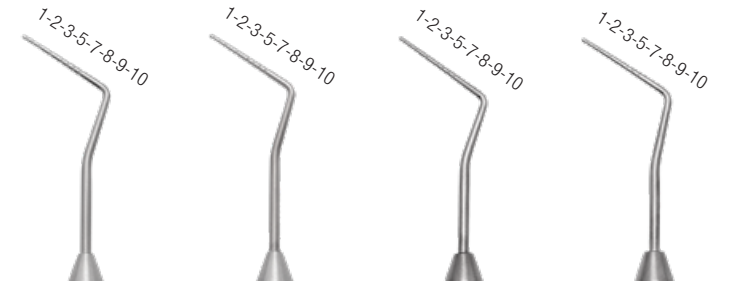

567/3
Williams
Explorer N. 3

567/16
Williams
Explorer N. 16

567/17
Williams
Explorer N. 17

567/23
Williams
Explorer N. 23



PERIODONTAL PROBES SONDE PARODONTALI



Periodontal probes with technical coating DLC (Diamond Like Carbon):

- ▷ Black background to highlight the contrast ratio for better reading
- ▷ Rounded tip to prevent traumatic issue
- ▷ Accurate millimeter scale markings realized by laser
- ▷ Atraumatic scale non-grooved for a smooth transition
- ▷ Non fading scale

Sonde parodontali con rivestimento tecnico DLC (Diamond Like Carbon):

- ▷ Base nera per elevare il contrasto di lettura
- ▷ Punta arrotondata per non creare traumi
- ▷ Scala metrica precisa realizzata a laser
- ▷ Scala metrica non traumatica per assenza scanalature
- ▷ Non scolora

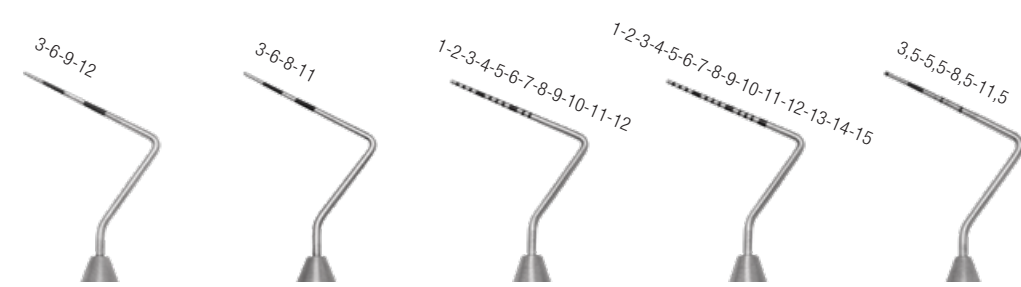

548/1 CP12
548/2 CP11
548/3 CP12 UNC University of North Carolina
548/4 CP15 UNC University of North Carolina
548/5 Who



Periodontal standard probes with scale black markings obtained through CNC process.
Sonde parodontali tradizionali con scala metrica tornita a CNC di colore nero.

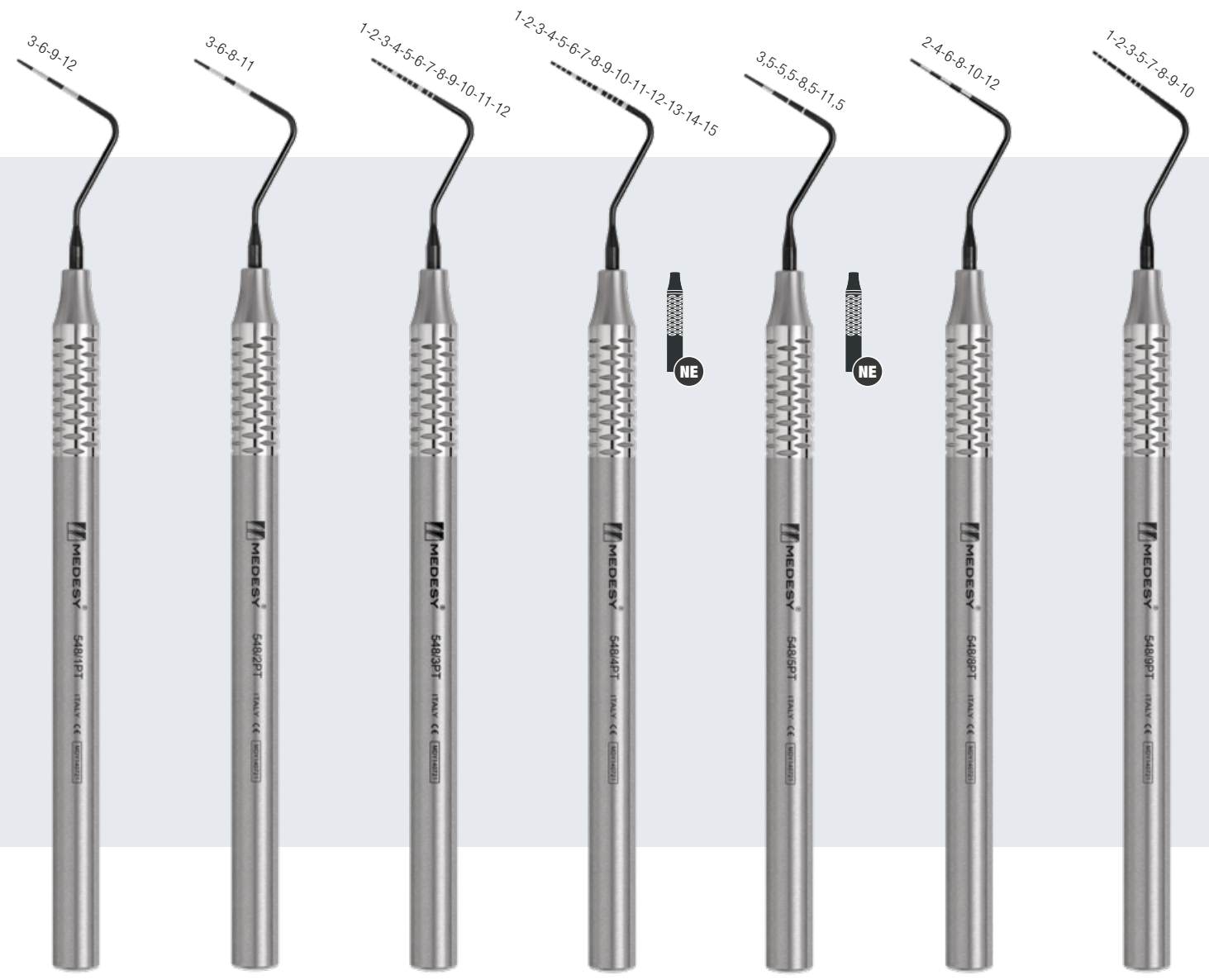

548/1 PT CP12
548/2 PT CP11
548/3 PT CP12 UNC University of North Carolina
548/4 PT 548/4 PT.NE CP15 UNC University of North Carolina
548/5 PT 548/5 PT.NE Who
548/8 PT CP22
548/9 PT Williams

NEWS



546/1
(1:1 scale / scala 1:1)

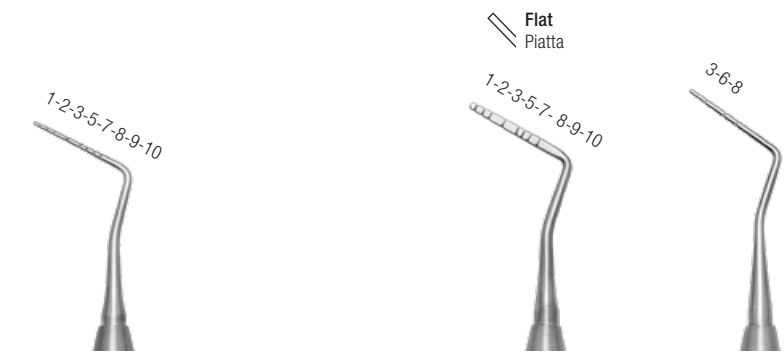

546/1 Williams
546/4 Goldman Fox
546/5 Michigan "0"

Periodontal standard probes with scale non colored low relief markings obtained through CNC process.
Sonde parodontali con scala metrica tornita a CNC in basso rilievo priva di colorazione.





Plastic periodontal probes realized with high quality polymers, approved for medical use.

- ▷ Best indicated for use in implantology to avoid damages on implants
- ▷ Rounded tip to prevent traumatic issues
- ▷ Black scale markings on white background for better contrast reading

Sonde parodontali plastiche realizzate con polimeri di alta qualità approvati per uso medico.

- ▷ Indicate in implantologia per non danneggiare l'impianto
- ▷ Punta arrotondata per non creare traumi
- ▷ Scala metrica nera su una base bianca migliora la lettura

The periodontal tips can be assembled on all mirrors handles having metric thread. The tips are reusable until the scale markings are readable and / or the tips start to deform.

Le punte parodontali possono essere utilizzate su tutti i manici per specchietti aventi filettatura metrica. Le punte sono riutilizzabili fintanto che la scala rimane leggibile e/o la punta non si deforma.



NEWS



3-6-9-12



549/1

CP12
Package 6 pcs
Confezione 6 pz

3-6-8-11



549/2

CP11
Package 6 pcs
Confezione 6 pz

1-2-3-4-5-6-7-8-9-10-11-12-13-14-15



549/4

CP15 UNC
Package 6 pcs
Confezione 6 pz

3,5-5,5-8,5-11,5



549/5

WHO
Package 6 pcs
Confezione 6 pz